

Panasonic

2-Way FRS Radio

Model No. KX-TR320B/KX-TR320F
KX-TR320S/KX-TR325S

Operating Instructions

Palm Link™

**PLEASE READ BEFORE USE
AND SAVE.**

Contents by Section

- 1 Getting Started
- 2 Before You Talk
- 3 To Communicate
- 4 Channel Scan
- 5 Special Features
- 6 Using the Options
- 7 Things You Should Know



KX-TR325S

Panasonic World Wide Web address: <http://www.panasonic.com>
for customers in the USA or Puerto Rico

Attach your purchase receipt here.

For your future reference

Serial No. _____ Date of purchase _____
(found on the bottom of the unit)

Name and address of dealer _____

For product service

- Panasonic Servicenters are listed in the servicenter directory.
- Call 1-800-211-PANA(7262) for the location of an authorized servicenter.
- Panasonic's e-mail address for customer inquiries:
consumerproducts@panasonic.com
for customers in the USA or Puerto Rico ONLY

When you ship the product

- Carefully pack your unit, preferably in the original carton.
- Attach a letter, detailing the symptom, to the outside of the carton.

Symptom _____

- Send the unit to an authorized servicenter, prepaid and adequately insured.
- Do not send your unit to the Panasonic Consumer Electronics Company listed below or to executive or regional sales offices. These locations do not repair consumer products.

Panasonic Consumer Electronics Company,
Division of Matsushita Electric Corporation of America
One Panasonic Way, Secaucus, New Jersey 07094

Panasonic Sales Company,
Division of Matsushita Electric of Puerto Rico, Inc.
Ave. 65 de Infantería, Km. 9.5, San Gabriel Industrial Park
Carolina, Puerto Rico 00985

1 Getting Started



1-A Location of Controls

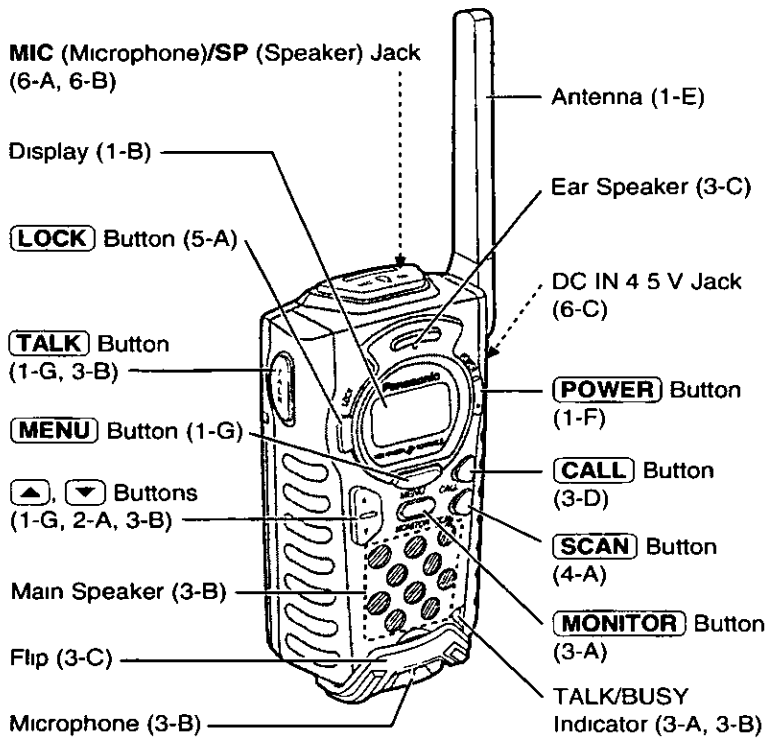

•The illustrations used in this manual are of the KX-TR325

Accessory (For extra orders, call 1-800-332-5368)

- Belt Clip one
Order No. PQKE10094Z1

1-B Display

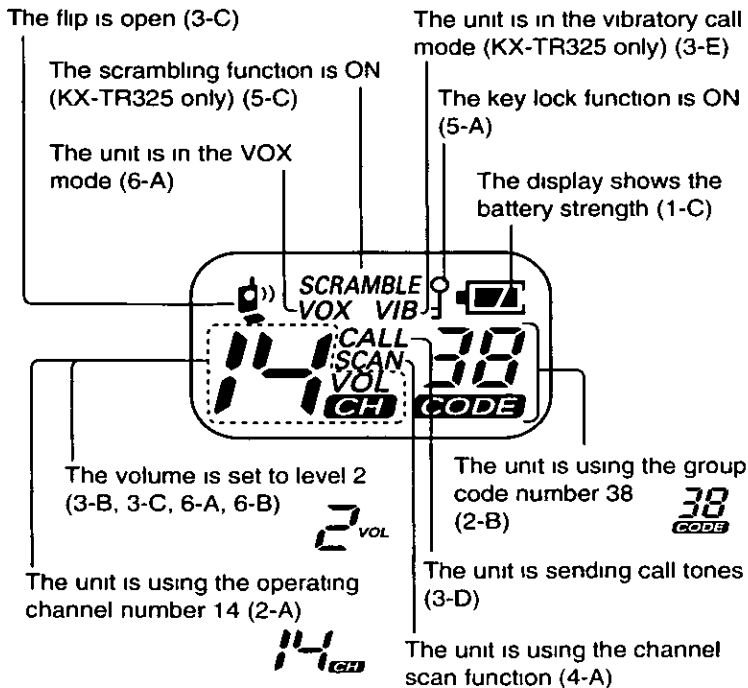

1-C Battery Installation

The unit requires 3 AA (LR6) size alkaline batteries (not included). The battery life is about 30 hours (Based on a usage duty of 5% receive, 5% talk, 90% standby).

- 1 Pull down the hook and remove the cover
- 2 Install (or replace) the batteries using the correct polarity (+, -)

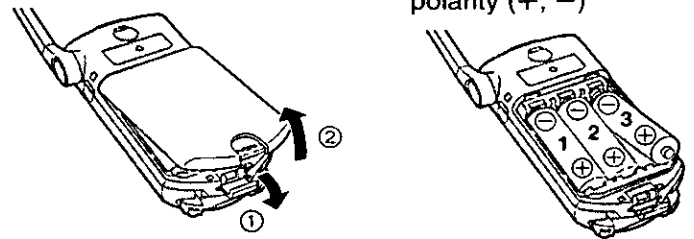

- 3 Close the cover

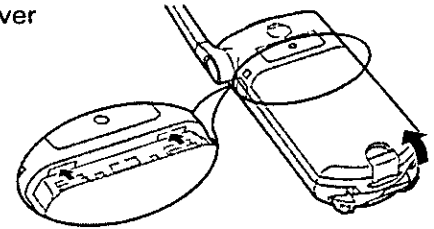

- Make sure that the unit is powered OFF before replacing the batteries

Battery precautions

The batteries should be used correctly, otherwise the unit may be damaged by battery leakage.

- Do not mix different types of batteries
- Do not charge, short-circuit, disassemble or heat batteries, and do not dispose of batteries in fire
- Remove all the batteries when replacing

Battery strength

You can check the battery strength on the display (see below) while the unit is in use. If the unit beeps intermittently and "🔋" flashes on the display, replace all the batteries with new ones.

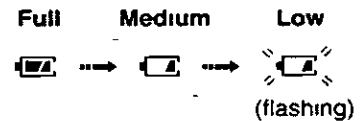

- If the unit is left on when the battery is LOW, everything, except the flashing "🔋", will disappear from the display. Only **POWER** can be operated to turn the unit off.
- Battery life may vary depending on usage conditions and ambient temperature.

1-D Belt Clip

You can hang the unit on your belt or pocket using the belt clip.

To attach the belt clip

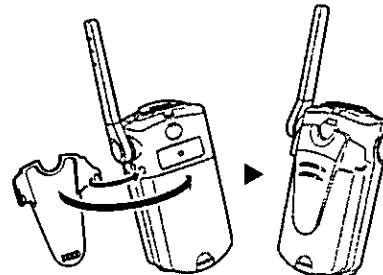

To remove the belt clip

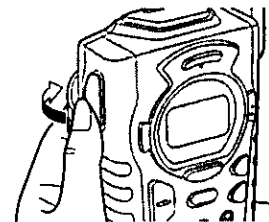

1-E Adjusting the Antenna

The antenna rotates 360 degrees. You can adjust the antenna to three different click positions. For best performance, the antenna should be used in the vertical position.

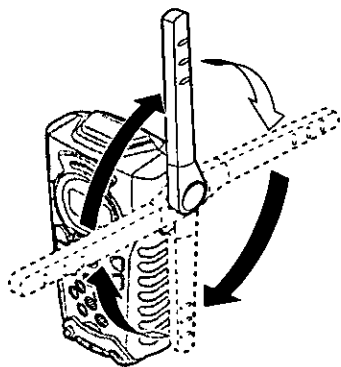

1-F Turning the Power ON/OFF

- Press and hold **POWER**.
• The display will appear.
- To turn the power off, press and hold **POWER** until the display disappears.

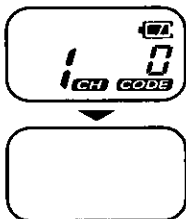

1-G Programming Summary

You can program the following functions. See the corresponding section number for details.

Each time you press **MENU**, the display will change as follows.

	The display shows the current channel and group code.
	To select the operating channel, see 2-A.
	To select the group code, see 2-B.
	To select the VOX sensitivity, see 6-A.
	To change the call tones, see 3-D.
	To turn on/off the vibratory call, see 3-E. (KX-TR325 only)
	To turn on/off the scrambling function, see 5-C. (KX-TR325 only)
	To select the auto power off mode, see 5-B.

Press or for the desired settings.

When finished, press **TALK** or wait for 10 seconds.

• You can exit the programming mode any time by pressing **TALK** or waiting for 10 seconds.

The unit has 14 operating frequency channels and 38 group codes. To talk to others, all users in your group must be using the same channel and group code.

2-A Selecting the Operating Channel

The factory preset is "1".

- Press **MENU**.
• "CH" and the current channel will flash on the display.
- Press or repeatedly until the desired operating channel (1-14) is displayed.
- When finished, press **TALK** or wait for 10 seconds.

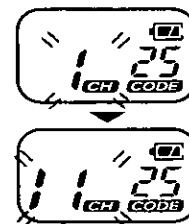

• The selected channel will not be cleared even when you turn off the unit.

2-B Selecting the Group Code (CTCSS)

The Continuous Tone Coded Squelch System (CTCSS) allows you to ignore (not hear) unwanted calls from other persons who are using the same channel. It provides communication with silent standby since you will only receive calls from group members using the same group code. The unit is equipped with 38 group codes. The factory preset is "0" (OFF).

The CTCSS does not make your conversation private. It only allows you to not listen to unwanted conversations.

- Press **MENU** twice.
• "CODE" and the current group code will flash on the display.
- Press or repeatedly until the desired group code (0-38) is displayed (see below).
- When finished, press **TALK** or wait for 10 seconds.

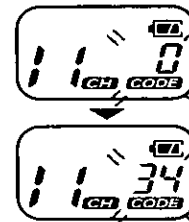

- The selected code will not be cleared even when you turn off the unit.
- To communicate with others without a group code, select "0" (OFF) in step 2.

CTCSS code (unit: Hz)

No.	Freq.	No.	Freq.	No.	Freq.	No.	Freq.
1	67.0	11	97.4	21	136.5	31	192.8
2	71.9	12	100.0	22	141.3	32	203.5
3	74.4	13	103.5	23	146.2	33	210.7
4	77.0	14	107.2	24	151.4	34	218.1
5	79.7	15	110.9	25	156.7	35	225.7
6	82.5	16	114.8	26	162.2	36	233.6
7	85.4	17	118.8	27	167.9	37	241.8
8	88.5	18	123.0	28	173.8	38	250.3
9	91.5	19	127.3	29	179.9	0	OFF
10	94.8	20	131.8	30	186.2		



Backlit LCD Display

The lighted display will remain on for about 5 seconds after pressing any button except **TALK** or closing the flip.

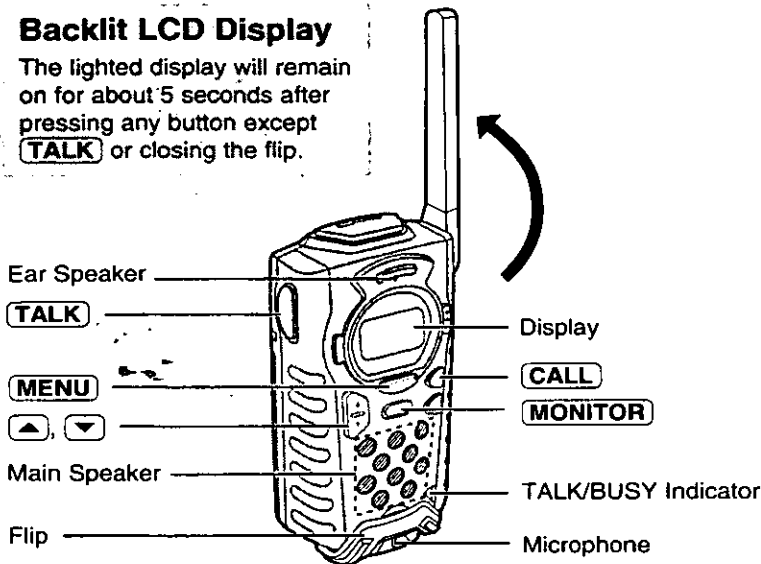

3-A Monitor

The monitor function activates the speaker. Use this function when received signals are too weak to recognize. You can use the monitor function to check activity on the current channel before transmission.

- 1 Press and hold **MONITOR** to open the squelch.
 - The TALK/BUSY indicator lights green.
 - You will hear static if the channel is clear for use.
 - 2 Release **MONITOR** to close the squelch.
 - The TALK/BUSY indicator light goes out.
- If you want to use the monitor privately, open the flip before pressing **MONITOR**.

3-B Sending/Receiving Messages

- 1 Check the current channel activity (3-A).
 - Do not talk if someone is already on the channel.
 - 2 Press and hold **TALK** to transmit and talk into the microphone.
 - The TALK/BUSY indicator lights red.
 - 3 To receive, release **TALK**.
 - The TALK/BUSY indicator lights green.
 - Repeat steps 2 and 3 to continue communication.
- To maximize readability of your transmitted signal, pause a few seconds after pressing **TALK**, hold the unit 2 to 4 inches (5 to 10 cm) from your mouth and speak at a normal voice level.
- For safe motor vehicle operation, please do not use the unit while driving. Either stop vehicle or allow passenger to use instead.



To select the main speaker volume

The factory preset is "5".

- 1 Press \downarrow or \uparrow .
 - "VOL" and the current volume level will flash on the display.
- 2 Press \downarrow or \uparrow repeatedly until the desired volume level (1-8) is displayed.

3-C Private Talk

If you want to talk privately during transmission, open the flip. The unit enters the private talk mode. You can transmit by holding the unit near your ear like a telephone handset.

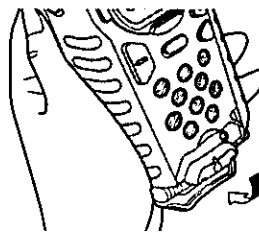

- 1 Open the flip and check the current channel activity (3-A).
 - "E" and "VOX" are displayed.
 - Do not talk if someone is already on the channel.
 - 2 Press and hold **TALK** to transmit and talk into the microphone.
 - The TALK/BUSY indicator lights red.
 - 3 To receive, release **TALK**.
 - You can hear the other party's voice through the ear speaker.
 - The TALK/BUSY indicator lights green.
 - 4 When finished, close the flip.
 - "E" and "VOX" will disappear.
- To maximize readability of your transmitted signal, pause a few seconds after pressing **TALK** and speak.

To select the ear speaker volume

The factory preset is "2".

- 1 Open the flip and press \downarrow or \uparrow .
 - "VOL" and the current volume level will flash on the display.
- 2 Press \downarrow or \uparrow repeatedly until the desired volume level (1-3) is displayed.
- 3 When finished, close the flip.

3-D Call Tones

The unit has five different call tones to identify each user and alert others that you intend to transmit. When you press **CALL**, the other party will be alerted with your call tones.

To send call tones

- Press **CALL**.
 - The TALK/BUSY indicator lights red.
 - "CALL" is displayed and the call tones sound.
 - The other party will be alerted with the call tones.
- The call tones will sound continuously if you press and hold **CALL**.
- If you want to send the call tones privately, open the flip before pressing **CALL**.

To change the call tones

The factory preset is "1".

- Press **MENU** four times.
 - "CALL" and the current setting will flash on the display.
- Press **▼** or **▲** repeatedly until the desired setting (1–5) is displayed.
 - Each time you press the button, the selected call tones will sound.
- When finished, press **TALK** or wait for 10 seconds.

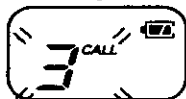
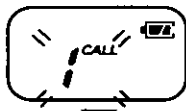

3-E Vibratory Call (KX-TR325 only)

KX-TR325 allows you to receive a vibratory call instead of a message or call tones (—"Vibe Ringer"). This is useful in noisy locations, or when quiet is required. The factory preset is OFF.

To turn on/off the vibratory call mode

- Press **MENU** five times.
 - "VIB" and the current setting will flash on the display.
- Press **▼** or **▲** to turn on/off the vibratory call mode.
- When finished, press **TALK** or wait for 10 seconds.
 - When set to ON, "VIB" will remain on the display.

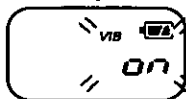

When you receive a vibratory call

The unit vibrates while the other party is sending a message or call tones.

- To hear the other party, press **MONITOR**.
- To transmit, press and hold **TALK** or open the flip, and talk into the microphone.

The vibratory call mode is temporarily turned off during transmission. 30 seconds after transmission is complete, the unit will return to the vibratory call mode.

- The vibratory call mode is turned off while the flip is opened. When you close the flip, the unit will return to the vibratory call mode.

4-A Finding a Busy Channel

Channel scan allows you to monitor 14 channels and a selected group code. When the unit detects channel activity on your selected code, it stops scanning and locks in on the busy channel. You can listen and talk back (within 5 seconds of the end of a transmission) on the displayed channel without having to change your settings.

- Press **SCAN**.
 - "SCAN" will flash on the display.
 - Channel scan starts and monitors the channels from the current channel in the order below.
1→2→3-----→14
- The unit stops scanning when it finds a busy channel, and you will hear a message.
 - The TALK/BUSY indicator lights green.

If you want to scan other busy channels, press **▲** to scroll up or **▼** to scroll down.

 - Channel scan starts again.
 - If no message is received or there is no key operation for about 5 seconds, channel scan starts again.
- To end the channel scan, press **SCAN**.
 - The unit will return to the standby mode with the preset channel and group code.

To transmit during channel scan

- Follow steps 1 and 2 of the channel scan procedure above.
 - When the unit finds the desired busy channel and stops scanning, press **TALK** within 5 seconds (or during the message).
 - To transmit, press and hold **TALK** and talk into the microphone.
To receive, release **TALK**.
 - After transmission, the unit will return to the standby mode showing the current channel and group code.
- If you want to scan privately, open the flip before pressing **SCAN**.
- To communicate in channel scan mode, your unit must be set to the same group code as the other user(s) in your group. If your unit is set to a different code, the channel scan function will not detect channel activity in your group.
- To scan for radios without a group code, set your group code to "0" (OFF) before using the channel scan function.

5-A Key Lock

Key lock allows you to lock some buttons (**POWER**, **MENU**, **▼**, **▲** and **SCAN**) to prevent accidentally changing any radio settings.

- Press and hold **LOCK** until "?" is displayed.
- To turn the key lock function OFF, press and hold **LOCK** until "?" disappears.

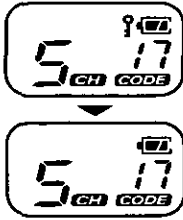

While the Key Lock function is ON, the following features can still be used.

- Sending/Receiving messages
- Sending/Receiving call tones
- Monitor
- Private talk

5-B Auto Power OFF

The unit can be programmed to turn itself off after a certain period of no operation. This is useful to save the battery life. You can select the time period for the auto power off mode. The factory preset is "2" (2 hours).

- Press **MENU** five times (seven times if your model is a KX-TR325).
 - The current setting will flash on the display.
- Press **▼** or **▲** repeatedly until the desired setting (0-3) is displayed.
 - 1: 1 hour 2: 2 hours 3: 3 hours
 - 0: OFF
- When finished, press **TALK** or wait for 10 seconds.

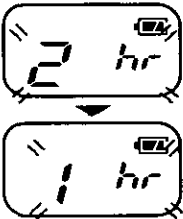

• The auto power off function can be used whether the Key Lock function is active or not (5-A).

5-C Scrambling (KX-TR325 only)

KX-TR325 allows you to scramble your calls so that others will not understand your conversation. This is only possible with KX-TR325. The factory preset is OFF.

- Press **MENU** six times.
 - "SCRAMBLE" and the current setting will flash on the display.
- Press **▼** or **▲** to turn on/off the scrambling function.
- When finished, press **TALK** or wait for 10 seconds.
 - When set to ON, "SCRAMBLE" will remain on the display.

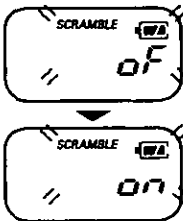

6-A To Enjoy Hands-Free Operation

The unit has built-in Voice Activated Transmission (VOX) capability. Using a Headset Mic (KX-TRA10) or Earbud Mic (KX-TRA17) with the unit, you can activate the transmission with your voice.

The unit must be powered off before connection.

The unit enters the VOX mode when the unit is powered ON after the Headset Mic or the Earbud Mic is connected to the unit.

• "VOX" is displayed.

• To switch to the PTT (Push-To-Talk) mode, press **TALK**. To return to the VOX mode, turn the unit off, then on again.

For details, see the Headset Mic or Earbud Mic operating instructions.

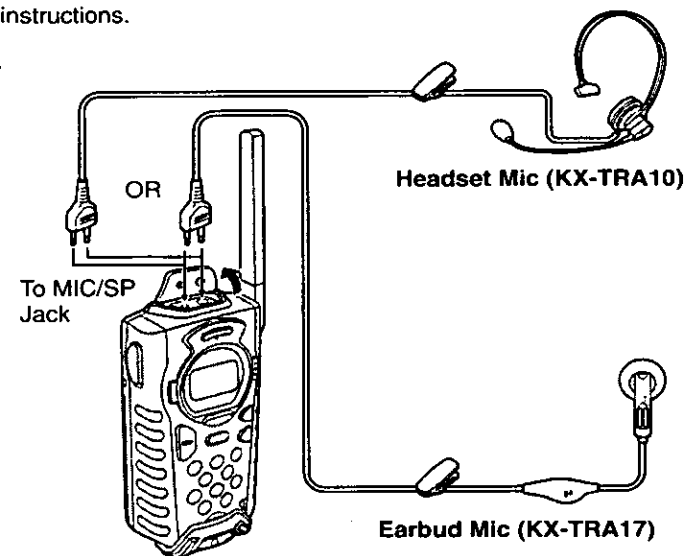

- There will be a brief delay between starting/stopping talking and radio transmission in the VOX mode.
- You cannot send a message while receiving in the VOX mode. Wait until the other party stops talking.
- When you finished using the Headset Mic or Earbud Mic, unplug the Headset Mic or Earbud Mic from the MIC/SP jack to save the battery life.

To select the receiver volume

The factory preset is "2".

- 1 Press **▼** or **▲**.
• "VOL" and the current volume level will flash on the display.
- 2 Press **▼** or **▲** repeatedly until the desired volume level (1-3) is displayed.

To select VOX sensitivity

You can select the VOX sensitivity of the radio to compensate for varying levels of noise around you. The factory preset is "2" (Medium).

- 1 Press **MENU** three times.
• "VOX" and the current setting will flash on the display.
- 2 Press **▼** or **▲** repeatedly until the desired setting (1-3) is displayed.
• 1: Low (for high levels of noise)
• 2: Medium (for use in most applications)
• 3: High (for low levels of noise)

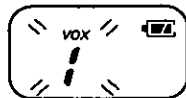
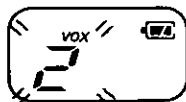

- 3 When finished, press **TALK** or wait for 10 seconds.

6-B To Operate with a Speaker Mic

Using a Speaker Mic (KX-TRA15) with the unit, you can operate the unit remotely.

The unit must be powered off before connection.

For details, see the operating instructions for the Speaker Mic.

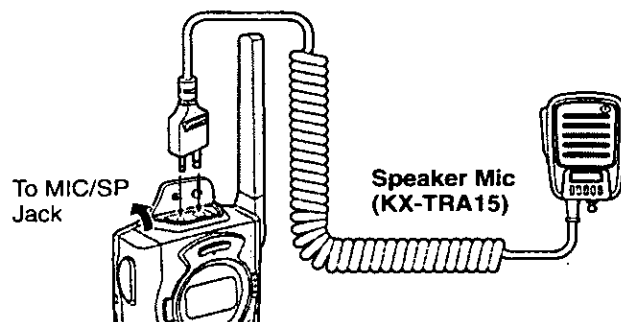

- When you finished using the Speaker Mic, unplug the Speaker Mic from the MIC/SP jack to save the battery life.

To select the receiver volume

The factory preset is "5".

- 1 Press **▼** or **▲**.
• "VOL" and the current volume level will flash on the display.
- 2 Press **▼** or **▲** repeatedly until the desired volume level (1-8) is displayed.

6-C For Use with a Car Battery

If you connect the unit to the cigarette lighter socket of your car using a Car DC Power Adaptor (KX-TRA20), you can enjoy transmitting without thinking about the battery life.

The unit must be powered off before connection.

For details, see the operating instructions for the Car DC Power Adaptor.

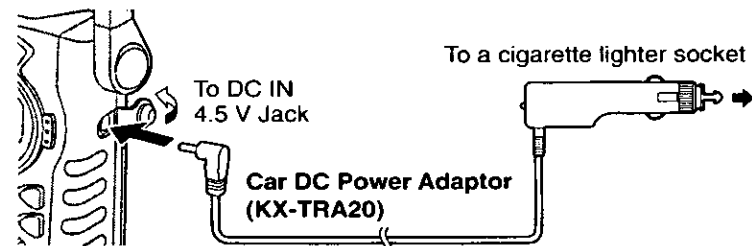

- The unit will not run on batteries as long as the DC IN 4.5 V jack is plugged in.
- Use only Panasonic Car DC Power Adaptor (KX-TRA20). Using any other car DC power adaptor may cause damage to the unit.
- The Car DC Power Adaptor cannot be used to charge the rechargeable battery.

6-D Carrying Case

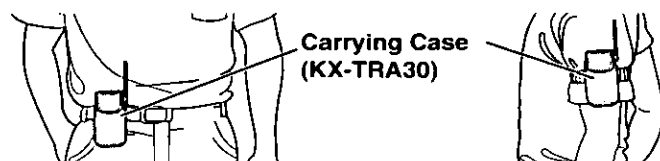

You can hang the unit on your belt or arm using a carrying case (KX-TRA30).



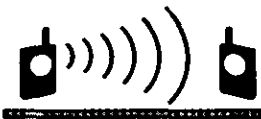
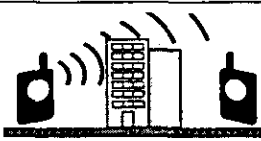

7-A Talk Range

The unit is designed to maximize performance and improve transmission range in the field. However, the talk range depends on your surrounding environment. This unit is a "line of sight" radio and therefore talk range will be affected by concrete structures, heavy foliage and transmission from inside a building or vehicle.

Optimal Range	Range in flat, open areas is up to 2 miles.	
Medium Range	Range is decreased when buildings and trees are in the way.	
Minimal Range	Dense foliage and mountains can limit range.	

7-C Before Requesting Help

Problem	Remedy
You press POWER to power the unit ON, but the unit does not work.	<ul style="list-style-type: none"> • Reposition or replace batteries (1-C). • Make sure the unit is unlocked (5-A).
Your message cannot be transmitted.	<ul style="list-style-type: none"> • Make sure TALK is firmly pressed and held when you transmit. • Reposition or replace batteries (1-C). • You cannot send a message while receiving using the Headset Mic (KX-TRA10) or the Earbud Mic (KX-TRA17). Wait until the other party stops talking. • Change the VOX sensitivity according to the noise around you in the VOX mode (6-A).
The other party's message cannot be received.	<ul style="list-style-type: none"> • Make sure the other party's channel/code settings are the same as yours. • Make sure TALK is not inadvertently being pressed. • Reposition or replace batteries (1-C). • Obstructions, operating indoors or in vehicles, may interfere with communication. Change your location and try again. • Hold the unit near your ear to hear the message from the ear speaker when the flip is open. • Change the VOX sensitivity according to the noise around you in the VOX mode (6-A).
Other conversations or noise on a channel is heard when receiving.	<ul style="list-style-type: none"> • Confirm the group code setting (2-B). If the setting is "0" (OFF), reprogram the same group code as the other party, and try again. • Shared channel or group code may be in use. Try another.

7-B Specifications

Operating frequency	462.5625–462.7125 MHz 467.5625–467.7125 MHz 14 channels 38 codes
Power requirements	4.5 V DC, 3 AA (LR6) size alkaline batteries (not included)
External power source	DC IN 4.5 V jack accepts: 12 V negative ground car battery with Car DC Power Adaptor (optional)
Alkaline battery life	Approx. 30 hours (Based on a usage duty of 5% receive, 5% talk, 90% standby)

Design and specifications are subject to change without notice.

Channel frequency chart

(unit: MHz)

Ch	Freq.	Ch	Freq.	Ch	Freq.
1	462.5625	6	462.6875	11	467.6375
2	462.5875	7	462.7125	12	467.6625
3	462.6125	8	467.5625	13	467.6875
4	462.6375	9	467.5875	14	467.7125
5	462.6625	10	467.6125		

Problem	Remedy
You cannot change channel/code settings.	<ul style="list-style-type: none"> • Make sure the unit is unlocked (5-A).
Limited Talk Range	<ul style="list-style-type: none"> • Steel/concrete structures, heavy foliage and use in buildings or vehicles will decrease range. Check for clear line of sight to improve transmission. • Wearing the unit on your body, such as in a pocket or on a belt, will decrease range. Change location of the unit.
Static, sound cuts in/out, fades. Interference emits when transmitting.	<ul style="list-style-type: none"> • You are too close to the other party. You should be at least 10 feet apart. Increase your distance. • You are too far from the other party. Obstacles interfere with transmission. Talk range is up to 2 miles in clear, unobstructed conditions.
The transmission suddenly stops while sending messages using TALK .	<ul style="list-style-type: none"> • The unit automatically returns to the standby mode if more than 60 seconds pass while sending messages using TALK. To continue, press and hold TALK again.
"  flashes on the display.	<ul style="list-style-type: none"> • Reposition or replace batteries (1-C).
The display is dim.	<ul style="list-style-type: none"> • Reposition or replace batteries (1-C).
If you cannot solve your problem	<ul style="list-style-type: none"> • Call our customer call center at 1-800-211-PANA(7262). • Panasonic's e-mail address for customer inquiries: consumerproducts@panasonic.com for customers in the USA or Puerto Rico ONLY

7-D Safety Instructions

Splash-Resistant

The unit is designed to be splash resistant. You can use the unit with wet hands.

CAUTION:

- Do not immerse in water or leave under running water.
- Keep the unit away from salt water.
- Avoid exposure to prolonged high humidity.
- Since water in the MIC/SP jack or DC IN 4.5 V jack may cause damage, close the rubber cap(s) when the optional accessory(ies) is(are) not in use. When the optional accessory(ies) is(are) connected, do not use the unit with wet hands.
- If the unit is wet, wipe with a soft dry cloth.

Shock-Resistant

Although the unit is designed to be shock resistant, do not throw or step on the unit.

CAUTION:

To reduce the risk of fire or injury to persons, read and follow these instructions.

1. Use only the battery(ies) specified.
2. Do not dispose of the battery(ies) in a fire. It(they) may explode. Check with local waste management codes for special disposal instructions.
3. Do not open or mutilate the battery(ies). Released electrolyte is corrosive and may cause burns or injury to the eyes or skin. The electrolyte may be toxic if swallowed.
4. Exercise care in handling battery(ies) in order not to short the battery(ies) to conductive materials such as rings, bracelets, and keys. The battery(ies) and/or conductor may overheat and cause burns.
5. Do not recharge the battery(ies) provided with or identified for use with this product. The battery(ies) may leak corrosive electrolyte or explode.
6. Do not attempt to rejuvenate the battery(ies) provided with or identified for use with this product by heating. Sudden release of battery electrolyte may occur causing burns or irritation to the eyes or skin.
7. Replace all batteries at the same time. Mixing fresh and discharged batteries could increase internal cell pressure and rupture the discharged batteries. (Applies to products employing more than one separately replaceable primary battery.)
8. When installing batteries observe the proper polarity or direction. Incorrect installation can cause charging, and may result in leakage or explosion. (Applies to products employing more than one separately replaceable primary battery.)
9. Remove the battery(ies) from this product if the product will not be used for a long period of time (several months or more). During this time the battery(ies) could leak in the product.
10. Discard the "dead" battery(ies) as soon as possible. The "dead" battery(ies) may leak in the product.
11. Do not store this product, or the battery(ies) provided with or identified for use with this product, in high temperature areas. Batteries that are stored in a freezer or refrigerator for the purpose of extending shelf life should be protected from condensation during storage and defrosting. Batteries should be stabilized at room temperature prior to use after cold storage.

7-E FCC and Other Information

This device complies with Part 15 of the FCC Rules. Operation is subject to the condition that this device may not cause harmful interference.

Privacy of communications may not be ensured when using this unit.

CAUTION:

Any changes or modifications not expressly approved by the party responsible for compliance could void the user's authority to operate this device.

Note:

This equipment has been tested and found to comply with the limits for a Class B digital device, pursuant to Part 15 of the FCC Rules. These limits are designed to provide reasonable protection against harmful interference in a residential installation. This equipment generates, uses, and can radiate radio frequency energy and, if not installed and used in accordance with the instructions, may cause harmful interference to radio communications. However, there is no guarantee that interference will not occur in a particular installation. If this equipment does cause harmful interference to radio or television reception, which can be determined by turning the equipment off and on, the user is encouraged to try to correct the interference by one or more of the following measures:

- Reorient or relocate the receiving antenna.
- Increase the separation between the equipment and receiver.
- Connect the equipment into an outlet on a circuit different from that to which the receiver is connected.
- Consult the dealer or an experienced radio/TV technician for help.

- **Environment**—do not leave the unit in a place where the temperature is less than -10°C (14°F) or greater than 50°C (122°F), such as in areas of direct sunlight, heating radiators or closed automobiles. Avoid excessive smoke, dust, mechanical vibration or shock. Keep the unit away from magnetic cards, such as bank cards, telephone cards, etc., as the magnet in the unit may cause the data on the card's magnetic strip to be erased.
- **For safe motor vehicle operation**—please do not use the unit while driving. Either stop vehicle or allow passenger to use instead.
- **Medical**—consult the manufacturer of any personal medical devices, such as pacemakers, to determine if they are adequately shielded from external RF (radio frequency) energy. (The unit operates in the frequency range of 462.5625 to 462.7125 MHz and 467.5625 to 467.7125 MHz, and the power output level is up to 0.5 watts.) Do not use the unit in health care facilities if any regulations posted in the area instruct you not to do so. Hospitals or health care facilities may be using equipment that could be sensitive to external RF (radio frequency) energy.
- **Routine care**—wipe the unit with a soft cloth. Do not use benzene, thinner, or any abrasive powder.
- **If there is any trouble**—consult an authorized Panasonic Factory Service Center.

- This unit is designed for use in the United States of America. Sale or use of this product in other countries may violate local laws.
- Ce appareil est conçu pour être utilisé aux États-Unis d'Amérique. La vente ou l'emploi de cet appareil dans certains autres pays peut constituer une infraction à la législation locale.
- Esta unidad fue elaborada para uso en los Estados Unidos de América. La venta o el empleo de este producto en ciertos países puede constituir violación de la legislación local.
- この製品は、日本国外での使用を目的として設計されており、日本国内での使用は法律違反となります。従って、当社では日本国内においては原則として修理などのサービスは致しかねます。

