

---

**ALINCO**

DUAL BAND FM TRANSCEIVER

# DJ-596T/E

## Instruction Manual

Thank you for purchasing this ALINCO transceiver. This instruction manual contains important safety and operation instructions. Please read it carefully before using the transceiver and be sure to keep it.



---

**ALINCO INC.**

## Notice

This equipment has been tested and found to comply with the limits for a Class B digital device, pursuant to part 15 of the FCC Rules. These limits are designed to provide reasonable protection against harmful interference in a residential installation. This equipment generates, uses, and can radiate radio frequency energy and, if not installed and used in accordance with the instruction manual, may cause harmful interference to radio communications. However, there is no guarantee that interference will not occur in a particular installation. If this equipment does cause harmful interference to radio or television reception, which can be determined by turning the equipment off and on, the user is encouraged to try to correct the interference by one or more of the following measures:

- Reorient or relocate the receiving antenna.
- Increase the separation between the equipment and receiver.
- Connect the equipment into an outlet on a circuit different from that to which the receiver is connected.
- Consult the dealer or an experienced radio/TV technician for help.



Tested to Comply  
With FCC Standards

### FOR HOME OR OFFICE USE

Information in this document is subject to change without notice or obligation. All brand names and trademarks are the property of their respective owners. Alinco cannot be liable for pictorial or typographical inaccuracies. Some parts, options and/or accessories are unavailable in certain areas. Changes or modifications not expressly approved by the party responsible for compliance could void the user's authority to operate the equipment.

Copyright © 1998 All rights reserved. No part of this document may be reproduced, copied, translated or transcribed in any form or by any means without the prior written permission of Alinco, Inc., Osaka, Japan.

English Edition Printed in Japan.

# Contents

---

<b>Before Operating the Transceiver</b> .....	5
■ Attention.....	5
■ Points to Note Before Transmitting.....	5
■ Points to Note When Using an External Power Supply.....	5
<b>1 Functions and Features</b> .....	6
1.1 Standard Accessories.....	6
<b>2 Accessories</b> .....	6
2.1 Attaching the Accessories.....	6
● Connecting and Disconnecting the Antenna.....	6
● Attaching the Hand Strap.....	6
● Attaching and Detaching the Belt Clip.....	7
● Attaching and Detaching the Battery Pack.....	7
● Prevent Short Circuiting the Battery Pack.....	8
● Battery Recharger (Wall Charger) (EDC-92).....	8
● Battery Level Indicator.....	8
<b>3 Control Functions</b> .....	9
3.1 Name and Operation of Transceiver Controls.....	9.10
3.2 DTMF Key Operations.....	11
3.3 Display.....	12
<b>4 Basic Operations</b> .....	13
4.1 Turning the Power ON.....	13
4.2 Adjusting the Squelch.....	13
4.3 Adjusting the Audio Volume.....	14
4.4 Operating Modes.....	14
■ Switching Between Modes.....	14
4.5 VFO Mode.....	15
■ Setting the Tuning Step.....	16
■ Offset / Split Functions.....	16
4.6 Memory Mode.....	17
■ Selecting a Memory Channel.....	17
■ Programming a Memory Channel.....	17
■ Clearing a Memory Channel.....	17
■ Contents of Memory Programming.....	18
4.7 Call Mode.....	18
■ Programming a Call Channel Frequency.....	19
4.8 Receiving.....	19
■ Monitoring.....	19
■ Switching between NFM and WFM.....	19
4.9 Transmitting.....	20
■ Selecting Transmitter Output Level.....	20
<b>5 Advanced Operations</b> .....	21
5.1 Scanning.....	21
■ VFO Scan.....	21
■ Memory Scan.....	21
■ Skip Channel Setting.....	21
5.2 Keylock.....	22
5.3 Tone Call.....	22
5.4 Channel Names.....	22
■ Setting.....	22
■ Channel Name Display.....	22
5.5 Lamp.....	23
<b>6 Communicating</b> .....	24
Selective Communicating.....	24
6.1 Tone Squelch.....	24
■ Tone Squelch Setting.....	24
■ Canceling Tone Squelch.....	24

■ Changing Tone Squelch Frequency.....	24	■ DTMF Wait Time.....	32
6.2 DCS (Digital Code Squelch).....	25	■ DTMF Burst / Pause Time.....	32
■ DCS Setting.....	25	■ DTMF First Digit Burst Time.....	32
■ Changing DCS Code.....	25	■ Theft Alarm.....	32,33
■ Canceling DCS.....	25	■ External Terminal Control.....	33
■ DCS Operation.....	25	■ Mosquito Repelling Signal.....	34
6.3 DTMF Manual Transmitting.....	26	■ End Peep.....	34
6.4 Auto Dialer.....	26	<b>8 Cloning and Packet Operation.....</b>	<b>35</b>
■ Auto Dialer Memory Setting.....	26	8.1 Cloning.....	35
■ Auto Dialer Output.....	27	■ Connecting the Transceivers.....	35
■ Redialing.....	27	■ Transmitting Data from the Master transceiver.....	35
6.5 TOT (Timeout Timer).....	28	■ Receiving the Master Data.....	35,36
■ Setting.....	28	8.2 Packet Operation.....	36
■ TOT Operation.....	28	■ Packet Operation Connections.....	36
6.6 APO (Auto Power Off).....	28	<b>9 Maintenance and Reference.....</b>	<b>37</b>
■ Setting.....	28	9.1 Troubleshooting.....	37
■ APO Operation.....	28	9.2 Resetting.....	38
6.7 BELL.....	28	9.3 Options.....	38
■ Setting.....	28	9.4 Transmission System.....	39
■ BELL Operation.....	28	<b>10 Specifications.....</b>	<b>40</b>
<b>7 Parameter Setting Mode.....</b>	<b>29</b>	● General.....	40
7.1 Mode Setting Commands.....	29	● Transmitter.....	40
7.2 Selecting the Parameters.....	29	● Receiver.....	40
7.3 Setting the Functions.....	30		
■ Battery Save.....	30		
■ Scan Type.....	30		
■ Beep.....	30		
■ Tone Call Frequency.....	30		
■ BCLO (Busy Channel Lock Out).....	31		
■ TOT Penalty.....	31		

# Before Operating the Transceiver

## ■ Attention

- Do not open the case or touch the interior components. Tampering can cause equipment trouble.
  - Do not expose the transceiver to direct sunlight, dusty places or place it near sources of heat.
  - Keep the transceiver away from TVs, tuners or other equipment if it interferes with reception.
  - Securely connect the antenna included with the transceiver.
  - When transmitting for a long time at high power, the transceiver can overheat.
  - Turn the power off immediately if the transceiver emits smoke or strange odors.
- Ensure that the transceiver is safe, then bring it to the nearest Alinco service center.

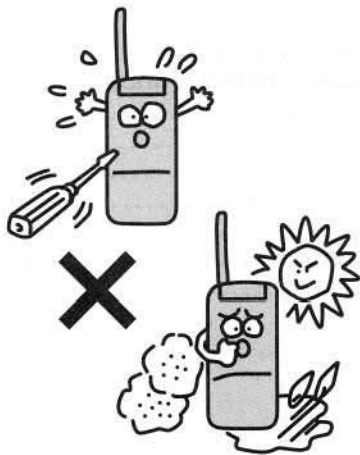

## ■ Points to Note Before Transmitting

Many wireless stations use frequencies adjacent to the ham bands for business purposes. Be mindful when transmitting near them.

Even when amateur stations obey regulations, unexpected interference can occur.

Pay sufficient attention during mobile operation.

**⚠ Caution** The use of a transceiver in the following places may be prohibited:

- Aboard aircraft
- In airports
- In shipping ports
- Within or near the operating area of business wireless stations or their relay stations.

Before using in any of the above places, obtain any necessary permission from the proper authorities, and be mindful of local laws that govern amateur radio operation.

## ■ Points to Note When Using an External Power Supply

- Use a 6.0V-16.0V DC external power supply.
- When connecting the power supply to the transceiver, use the optional DC cable for base station operation (ECD-37). Connect the cable to the DC jack on the side of the transceiver.
- When power is supplied from a cigarette socket of a car, use the cigarette lighter cable (EDC-43) or the cigarette lighter cable with filter (EDC-36). Use the cigarette lighter cable with filter (EDC-36) during mobile operation to prevent noise. Be sure the car's supply voltage and polarity are correct for use with your equipment.
- Turn the transceiver's power off when connecting or disconnecting the DC cable.

# 1. Functions and Features

- 39 CTCSS Tone Squelch settings
- 104 DCS Digital Code Squelch settings
- TOT (Timeout timer) function
- Channel naming feature
- Tone Call (burst) functions (1750,2100,1000,1450Hz and CALL)
- 9 Auto Dialer Memories
- Direct Frequency input function
- Cloning
- Theft Alarm function
- MRS (Experimental Mosquito Repelling Signal) function

## 1.1 Standard Accessories

- Ni-MH Battery Pack EBP-50N (9.6V 700mAh)
- Battery Recharger (EDC-93(120V), EDC-94(230V))
- Helical Antenna
- Belt Clip 2 pcs
- Hand Strap
- Instruction Manual
- Warranty Card

# 2. Accessories

## 2.1 Attaching the Accessories

### ● Connecting and Disconnecting the Antenna

· Connecting



1. Hold the antenna by its base.
2. Align the grooves at the base of the antenna with the protrusions on the antenna connector.
3. Slide the antenna down and turn it clockwise until it stops.
4. Confirm that the antenna is securely connected.

· Disconnecting

Turn the antenna counter-clockwise to disconnect the antenna.

### ● Attaching the Hand Strap



Attach the hand strap as shown in the illustration on the left.

## ● Attaching and Detaching the Belt Clip

### • Attaching

Attach the belt clip to the back of the transceiver and push it until it clicks.

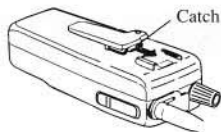

### • Detaching

Push up the catches of the belt clip, and pull it.

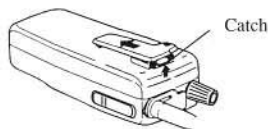

## ● Attaching and Detaching the Battery Pack

### • Attaching

Align the catches on the battery pack with the grooves on the transceiver, and push in the direction of the arrow until it clicks.

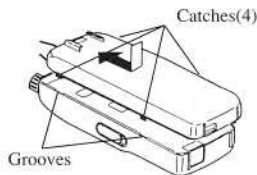

### • Detaching

Push up the catch at the bottom, and slide the battery pack out.

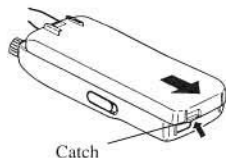

## ⚠ Caution

- The battery pack is not charged when shipped. It must be charged before using.
- It takes up to 12 hours (maximum) to fully charge the battery pack with the EDC-92.
- Charging should be conducted within a temperature range of 0 to 40 °C. (32-104 °F)
- Do not modify, dismantle, incinerate or immerse the battery pack in water, as these practices can be dangerous.
- Never short-circuit the battery pack terminals, as this can cause damage to the equipment or lead to overheating the battery, which could cause burns.
- Unnecessary prolonged charging (overcharging) can deteriorate battery performance.
- The battery pack should be stored in a dry place where the temperature is from -20 °C to -45 °C. (-4 °F - +113 °F)  
Temperatures outside this range can cause the battery liquid to leak. Exposure to prolonged high humidity can cause corrosion of metal components.
- Typically, the battery pack can be charged up to 500 times. However, the battery pack can be considered dead if the period of use drops significantly despite the pack being charged for the aforementioned charging time. When this happens, a new pack should be used.
- In the interests of environmental protection, do not dispose of the used battery pack improperly. Check with your local solid waste officials for details on recycling options or proper disposal in your area.
- The battery pack can be charged by mounting it on the DJ-596 and connecting 13.8VDC to the DC power supply jack on the transceiver.

## ● Prevent Short Circuiting the Battery Pack

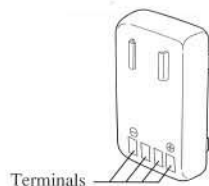

Be extra cautious when carrying the battery pack; short-circuiting will produce surge current possibly resulting in fire.

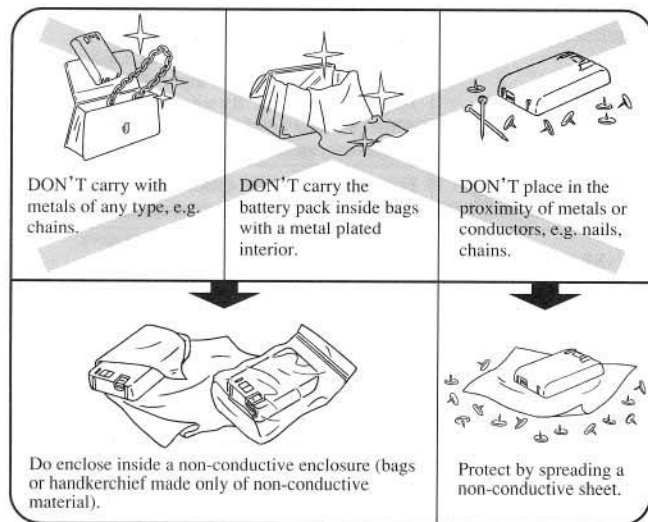

**⚠ Caution:** Keep the battery pack inside the included pouch when carrying.

## ● Battery Recharger (Wall Charger) (EDC-93/94)

Recharging



1. Mount the battery pack on the transceiver
2. Connect AC adapter plug to the external power supply jack on the transceiver.
3. Connect to the AC outlet.

- ⚠ Caution**
- Turn the transceiver power off before recharging the battery pack. (EDC-93/94)
  - Disconnect the EDC-93/94 from the outlet while not using it.
  - Never charge the battery packs of other manufacturers with this charger.
  - The required recharging time depends on the condition and model of battery pack. Refer to the instruction manual of the battery pack.
  - Never short-circuit the recharging terminals of this recharger with metal objects, etc. The charger can be damaged.
  - The EDC-93/94 does not work when the voltage from the wall outlet is extremely low.
  - The charger cannot be used to charge dry cell batteries, or used with the dry cell battery pack case.

## ● Battery Level Indicator

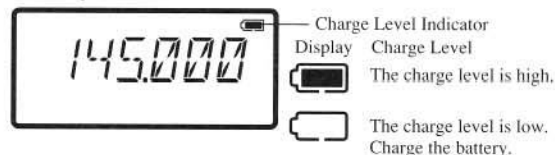

- Battery consumption level may change depending on the surrounding temperature or the frequency of use.
- Even if the battery monitor indicates the need for charging, you may be able to continue operations for low-output transmissions or reception.



# 3. Control Functions

## 3.1 Name and Operation of the Transceiver Controls

### Top and Front Views

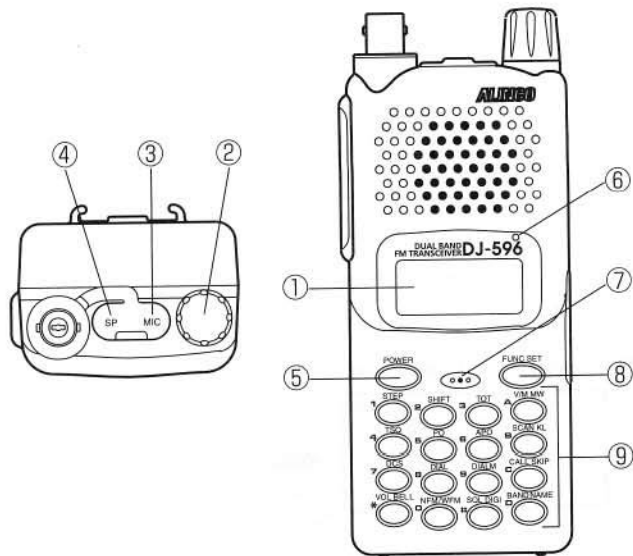

Key	Function	
①	Display (LCD)	Refer to "Display" in this manual. (Page 12)
②	Dial	Rotate this dial to select transmitting/receiving frequency, memory channel, offset frequency, tone frequency, DCS code, mode settings and input character for memory names. By rotating the dial while pressing and holding the FUN key, frequency can be adjusted by 1MHz steps.
③	MIC Connector	For connection of the optional external microphone (2kΩ) with 2.5Φ stereo plug.
④	SP Connector	For connection of the optional external speaker (8Ω) with 3.5Φ monophonic plug.
⑤	Power switch	For switching power ON/OFF.
⑥	TX/RX Lamp	Illuminated green when the squelch unmutates. Displays red when transmitting.
⑦	Microphone	Speak into microphone from a distance of approx. 5 cm.
⑧	FUNC key	Use this key in combination with other keys to access various functions of the transceiver. Holding this key for 3 seconds activates the Setting mode where various parameter adjustments are possible.
⑨	Key pads	Refer to "DTMF Key Operations". (Page 11)

■ Side View

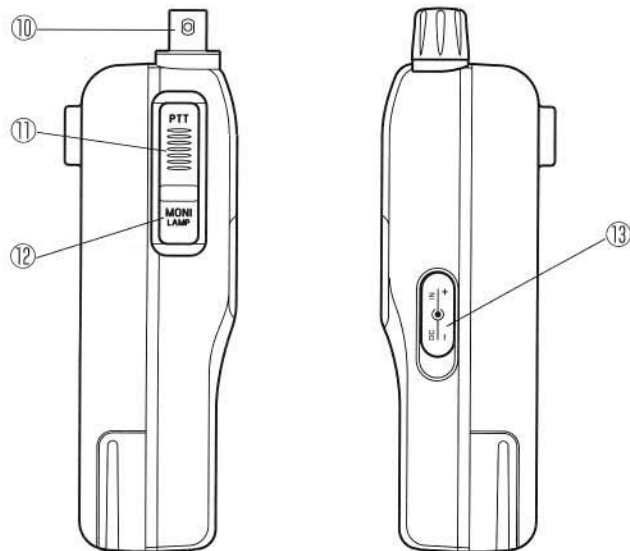



Key		Function
⑩	BNC Antenna Connector	For connection of the included helical antenna. If you use other antennas, choose one with low SWR (Standing Wave Ratio) designed for VHF and UHF frequencies.
⑪	PTT key	Press this key to transmit. When the key is released, the transceiver returns to the receive mode.
⑫	MONI key	When this key is pressed, the squelch is unmuted and you can hear the received signal. The squelch is also unmuted when TSQ/DCS are set. If this key is pressed while <b>[M]</b> appears, the lamp lights for five seconds. Pressing this key while the PTT key is pressed and held, transmits the tone call signal.
⑬	DC-IN	Terminal for connecting an external power supply. By connecting the optional cigarette lighter cable with filter (EDC-36), you can get power from a car. The pin in the center of the jack is + pole, and the surrounding part is - pole. Use a stable power supply with DC6.0~DC16.0V, 2A or more.

## 3.2 DTMF Key Operations

3

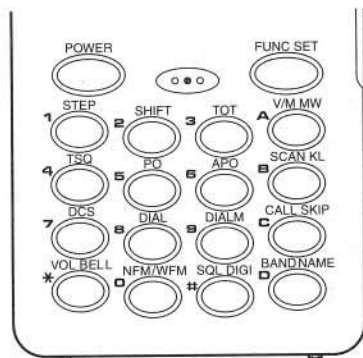



Control Functions

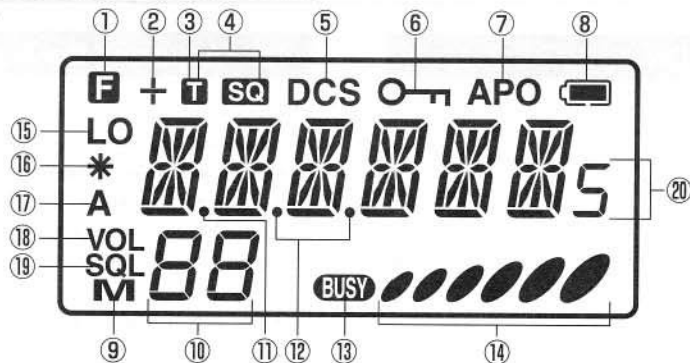

Key	Independent operation	While <b>F</b> appears after pressing the  key
1 STEP	Inputs "1"	Tuning Step setting (Page 16)
2 SHIFT	Inputs "2"	Shift / Split setting (Page 16)
3 TOT	Inputs "3"	TOT (timeout timer) setting (Page 28)
4 TSQ	Inputs "4"	Tone Squelch and Tone Encoder setting (Page 24)
5 PO	Inputs "5"	Selects the transmission output level HI/LOW (Page 20)
6 APO	Inputs "6"	APO (auto power off) setting (Page 28)
7 DCS	Inputs "7"	DCS (digital code squelch) setting (Page 25)
8 DIAL	Inputs "8"	Auto Dialer sending (Page 27)
9 DIALM	Inputs "9"	Auto Dialer memory setting (Page 26)
0 NFM/WFM	Inputs "0"	Selects NFM/WFM (Page 19)
A V/M MW	Switches VFO / Memory modes (Page ?)	Writes VFO information to a Memory Channel (Page 15)
B SCAN KL	Scanning Starts / Stops (Page ?)	Keylock setting (Page 22)
C CALL SKIP	Switches to Call mode (Page ?)	Skip Channel setting (Page 21)
D BANDNAME	Band change (Page ?)	Channel Name setting (Page 22)
# SQL DIGI	Squelch Level adjustment (Page ?)	—
* VOL BELL	Volume adjustment (Page ?)	BELL function setting (Page 28)

### 3.3 Display



①	<b>F</b>	Appears when the <small>PLINC SET</small>  key is pressed.	⑫	•	Divides MHz and kHz of the frequency. Blinks during scanning operation.
②	<b>+</b>	Indicates the offset frequency (−/+ ) direction.	⑬	<b>BUSY</b>	Appears when the squelch is unmuted.
③	<b>T</b>	Appears when the tone encoder is set.	⑭		Indicates received signal level and transmission output.
④	<b>T SQ</b>	Appears when the tone squelch is set.	⑮	<b>LO</b>	Appears when the transmitter output level is set to LOW.
⑤	<b>DCS</b>	Appears when the DCS is set.	⑯	<b>*</b>	Appears when the Theft Alarm is ON.
⑥		Appears when keys are locked.	⑰	<b>A</b>	Appears when NFM mode has been selected.
⑦	<b>APO</b>	Appears when Auto Power Off function is activated.	⑱	<b>VOL</b>	Appears while the audio volume is being adjusted.
⑧		Interior of the battery mark appears empty when the battery charge level becomes low.	⑲	<b>SQL</b>	Appears while squelch is being set.
⑨	<b>M</b>	Appears when the Memory mode is activated.	⑳		Indicates the frequency and status of various settings.
⑩	<b>88</b>	Indicates memory channel No. and other setting levels.			
⑪	•	Appears when external terminal control function is ON.			

## 4. Basic Operations

### 4.1 Turning the Power ON

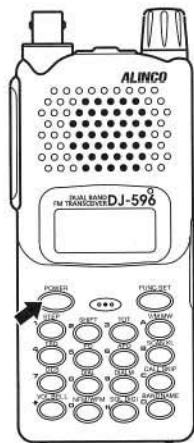

Hold the  key down for a second to turn the power ON.

To turn the power OFF, hold the power key down again for a second.

### 4.2 Adjusting the Squelch

The squelch silences the transceiver except for signals above a certain level. The Squelch eliminates noise when the transceiver receives less than a certain level.

“To unmute the squelch,” means that the transceiver receives a signal higher than the squelch setting and reproduces the received sound.

- There are 21 squelch levels (00 ~ 20).
- The default setting is 00 (minimum).

1. Press the  key. SQL and squelch level will appear on the LCD.



2. Adjust the squelch level by rotating the dial.  
A higher squelch level requires a stronger signal to unmute the squelch.
3. Press any key other than the MONI key to complete the setting.  
The setting function terminates automatically if no key is pressed within 5 seconds.

### 4.3 Adjusting the Audio Volume

- There are 21 volume levels (00 ~ 20).
- The default setting is 00 (minimum).

1. Press the  key. **VOL** and volume level will appear on the LCD.

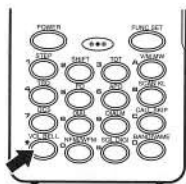

2. Adjust the volume level by rotating the dial.  
A higher volume level produces a louder sound.
3. Press any key other than the MONI key to complete the setting.  
The setting is automatically completed if no key is pressed within 5 seconds.

### 4.4 Operating Modes

The DJ-596 has three operating modes: VFO mode, MR (memory) mode and CALL mode.

The VFO mode has one VHF and one UHF channel. The MR mode has 100 channels (VHF/UHF mixture) and the CALL mode has one VHF and one UHF channel.

#### ■ Switching Between Modes

“VFO mode” and “MR mode” are switched by pressing the  key.

**M** appears on the display when “MR mode” is activated, and disappears when “VFO mode” is activated.

“CALL mode” is activated by pressing the  key. **C** appears on the display.

To return to the previous mode, press the  key again.

To switch between VFO VHF and VFO UHF, or CALL VHF/UHF, press the “BAND” key while in either of those modes.

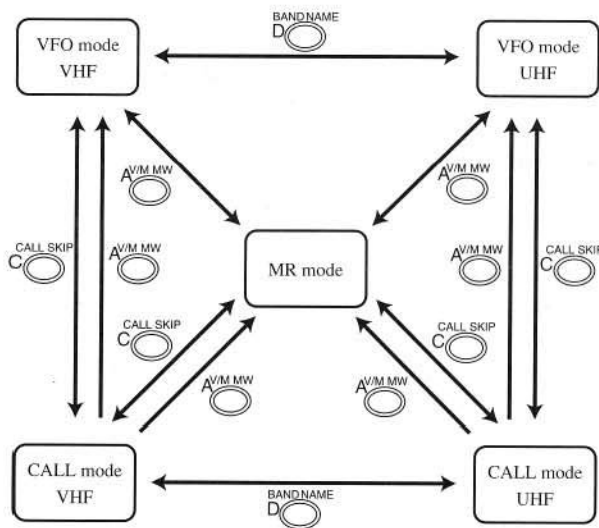

## 4.5 VFO Mode

The factory default setting for the DJ-596 is the VFO mode. The VFO mode allows you to change the frequency and other settings.



### ● Switching the Band

Press the  key to switch the band. Each press of the key changes the band as shown below.

Example: 145.00 → 433.00 → 145.00 → ... (DJ596E)

### ● 1MHz UP / DOWN

Select the VFO mode by pressing the  key.

Press the  key and rotate the dial while  appears. Frequency increases and decreases by 1MHz steps.

### ● Entry From the Keyboard

Select the VFO mode by pressing the  key.

Entry e.g.: 145.000MHz 1 → 4 → 5 → 0 → 0 → 0

(Tuning step : 5KHz)



Note If you want to cancel the keypad input, press a key other than number keys at any time while entering the number. The previous frequency will appear on the display again. The last digit entered must be in accordance with the currently selected tuning step.

### ● Entry Completion Digit for Different Tuning Steps

Depending on the tuning step, entry may be required to the 1 kHz digit or the 10 kHz digit.

Tuning step	Entry completion digit	Last digit selection
12.5kHz	10kHz	When you input the 10kHz digit, the 1kHz digit is defined as follows: {0}:00.0, {1}:12.5, {2}:25.0, {3}:37.5, {4}:invalid {5}:50.0, {6}:62.5, {7}:75.0, {8}:87.5, {9}:invalid
25.0kHz	10kHz	When you input the 10kHz digit, the 1kHz digit is defined as follows: (Other entries are invalid) {0}:00.0, {2}:25.0, {5}:50.0, {7}:75.0
5kHz	1kHz	Enter {5} for the 1kHz digit to enter 5kHz. Any other entry sets the 1kHz digit to 0.
Other	10kHz	When you input the 10kHz digit, the 1kHz digit is defined.

## ■ Setting the Tuning Step

- Press the  key in the VFO mode, and press the  key while  appears. The present tuning step is displayed. The tuning step changes as follows if you rotate the dial.

← DOWN                      UP →                      (kHz)

STP-5 → STP-10 → STP-12.5 → STP-15 → STP-20 → STP-25 → STP-30



- Press a key other than the MONI key to complete the setting.
- The tuning step default setting is 5kHz (DJ-596T), 12.5kHz (DJ-596E)
- The tuning step cannot be set in the Memory mode

Note The frequency and shift frequency may change if the tuning step is changed from (5kHz,10kHz,15kHz,20kHz,30kHz) to (12.5kHz,25kHz), or vice versa.

## ■ Offset / Split Functions

- Offset Function  
This function shifts the transmission frequency in relation to the receiving frequency.  
The default settings are: VHF: 0.6MHz, UHF: 5.0MHz
- Split Function  
This function changes the transmission frequency in relation to the receiving frequency.  
The transceiver receives the currently displayed VFO frequency, and transmits the other VFO frequency. Using this feature, it is possible to transmit on a VHF frequency and receive on a UHF frequency, or vice versa.

### ● Setting the Offset / Split Functions





Press the  key and the  key while  appears. Each press of the key changes the display as shown below.

[ - ]      [ + ]      [ | ]

0.600 → 0.600 → SPLIT → OST-OF

↑

(VHF)

- The displayed offset frequency can be adjusted by 1 tuning step by rotating the dial. If you want to change the frequency by 1 MHz steps, press the  key and rotate the dial while  appears.  
The setting is completed when a key other than the MONI and  keys is pressed.
- To set the split function, select "SPLIT" and press a key other than the MONI /  keys.  
The transceiver receives the displayed VFO frequency and transmits the other VFO frequency.



## 4.6 Memory Mode



In the Memory mode, you can call up and operate on a previously programmed frequency.

The DJ-596 has 100 memory channels (any VHF/UHF mixture).

It is not possible to increase the number of memory channels.

All memory channels are blank in the initial factory configuration or after resetting.



### ■ Selecting a Memory Channel

1. Press the  key to activate the Memory mode.  
The mode switches between Memory mode and VFO mode by pressing the  key.
2. **M** and a memory channel number appear when the Memory mode is activated.  
**M** blinks when the displayed channel is blank.



3. Rotate the dial to select a memory channel.  
Rotate the dial clockwise to choose a higher-numbered memory channel, and counterclockwise to select a lower-numbered memory channel.

### ■ Programming a Memory Channel

1. Press the  key to activate the Memory mode. Select a memory channel by rotating the dial.  
A blinking **M** indicates that the memory channel is blank.
2. Select a frequency you wish to program. You can also set Offset / Tone / DCS functions if necessary.
3. Press the  key and the  key while **F** appears. A beep is heard and memory channel programming is completed.



Reference

- If you want to rewrite a programmed memory channel, clear the programmed information before rewriting it. A memory channel is cleared by the above procedure 3, and **M** blinks when the memory is cleared and can be rewritten.
- Call channel can also be rewritten by selecting the memory channel [

### ■ Clearing a Memory Channel

1. Press the  key to activate the Memory mode.
2. Select a memory channel you wish to clear by rotating the dial.  
On a programmed channel, **M** is displayed steadily (without blinking).

3. Press the  key and the  key while  appears. A beep is heard and  programmed frequency is cleared. **M** starts blinking.

Reference If you want to retrieve the cleared information, press the  key and the  key while the previous memory channel information remains on the display. Note that this retrieving operation will not work if the memory channel or operating mode was changed after the memory was cleared.

## ■ Contents of Memory Programming

The following contents can be stored in each memory channel and in the CALL channels.

- Frequency
- Offset Frequency
- Shift Direction (+/-)
- Tone Encoder Frequency
- Tone Encoder / Decoder Setting
- Tone Decoder Frequency
- DCS Code
- DCS Setting
- Transmit Power H/L
- Skip Channel Setting
- Channel Name Setting
- W/N Setting
- Battery Save Setting
- Busy Channel Lock Out (BCLO)

## 4.7 Call Mode

The Call mode is used when you wish to receive or transmit on the Call channel.

The DJ-596 has 2 CALL channels (VHF and UHF).

The default settings are :

VHF : 145.00MHz, UHF : 445.00MHz (DJ-596T)

VHF : 145.00MHz, UHF : 433.00MHz (DJ-596E)

1. Press the  key to activate the Call mode.



2. CALL channel switches between VHF and UHF by pressing the  key in the Call mode.

3. To return to the VFO mode or the Memory mode, press the  key again.

The VFO mode or the Memory mode can also be reactivated by pressing the  key.



- Note
- In the Call mode, frequency and memory No. cannot be changed by rotating the Dial.
  - Offset, Tone, DCS settings can be temporarily changed.
  - Scanning cannot be performed in the Call mode.

## ■ Programming a Call Channel Frequency

A Call channel is one of the memory channels. To program the frequency and other settings of the call channel, select the memory channel in the VFO mode.

Note The Call channels can be programmed but cannot be cleared.

## 4.8 Receiving

1. Turn the power ON by pressing the  key.
2. Press the  key and rotate the dial to adjust the audio volume.
3. Press the  key and rotate the dial to eliminate the noise.
4. Adjust to the desired frequency.



When a signal is received on the selected frequency, **BUSY** appears on the display, the RF meter indicates relative signal strength, and the received signal is heard. The RX/TX Lamp displays green during reception.

## ■ Monitoring

The Monitor function unmutes the squelch temporarily to hear weak or unsteady signals.

- While the MONI key is pressed, the squelch is unmuted and sound is heard from the speaker regardless of the squelch setting.
- Monitoring can be performed even if the tone squelch or DCS are active.

## ■ Switching between NFM and WFM

1. The NFM/WFM mode is changed by pressing the  key and the  key while **F** appears. **A** appears when NFM is selected, and disappears when WFM is selected.  
NFM : **A**  
WFM : No indication
2. Press a key other than the MONI key or the  key to complete the setting. (Default setting: WFM)

Note When NFM is selected, the transmitted modulation also becomes half of the WFM value.





## 4.9 Transmitting

1. Select a frequency on which you want to transmit.
2. Press the PTT key to transmit. The RX/TX Lamp shows red when transmitting.
3. Speak into the microphone as you do in normal conversation. Do not shout.
4. Release the PTT key to stop transmitting and return to the receiving mode.

- Note
- A tone call (burst) signal can be transmitted by pressing and holding the PTT key and pressing the MONI key. (Page 22)
  - If the PTT key is pressed when the frequency is outside of the transmitting range, "OFF" appears on the display.
  - You cannot transmit when outside the range specified for your transceiver.

### ■ Selecting the Transmission Output Level

The transmission output level can be changed by the following operation:

- Press the  key and then  key while **F** appears. Transmission power is switched between HI and LOW. **LO** appears on the display when the transmitter output level is set to LOW, and nothing is indicated when HI is selected. Initial setting is LOW.
- The RF meter indicates LOW transmission power as , and HI transmission power as .

- Note Transmitter output level cannot be changed during transmission.

# 5. Advanced Operations

## 5.1 Scanning

You can automatically search for signals to receive by using the scan function.

You can select Timed Scan or Busy Channel Scan.

### Timed Scan

Scanning stops on a busy channel, and resumes five seconds later even if the frequency remains busy.



### Busy Channel Scan

Scanning resumes only after a received signal ceases.

- The decimal point blinks during scanning.
- If the MONI key is pressed during scanning, scanning stops temporarily and the squelch unmutes. When the MONI key is released, scanning restarts.
- Scanning direction can be changed by rotating the dial during the scanning operation.  
Scan starts in the last selected direction the next time the feature is activated.
- The Scan mode is cancelled by pressing a key other than the MONI key.

Reference Timed scan or busy channel scan can be selected in the Setting mode.(Page 30)



### ■ VFO Scan

1. Press the  key to activate the VFO mode.
2. Press the  key.

Scan starts in the last operated direction by tuning steps.



3. Scanning direction goes upwards by rotating the dial clockwise, and goes downwards by rotating the dial counterclockwise.
4. To stop scanning, press a key other than the MONI key.

### ■ Memory Scan



1. Press the  key to activate the Memory mode.
2. Press the  key to start scanning.
3. Scanning direction goes upward by rotating the dial clockwise, and goes downward by rotating the dial counterclockwise.
4. To stop scanning, press a key other than the MONI key.

### ■ Skip Channel Setting

Memory channels that have a “memory skip” programmed are not monitored during memory scanning.

- Press the  key in the Memory mode, and press the  key while  appears.  
The selected memory channel is now set as a skip channel. The skip channel setting is cancelled by the same operation.
- The 10MHz decimal point appears in a memory channel where a memory skip is programmed.

## 5.2 Keylock

To switch the keylock function ON/OFF, press the  key and then the  key while  appears.

-  appears when the key lock is ON.
- Operations of the PTT / LAMP / MONI keys, and the VOL / SQL controls are available even when the key lock is ON.

## 5.3 Tone Calls

The Tone Call function is used to call another station or activate a repeater by adding a tone signal to the transmitted radio wave.







- The tone signal is output while the MONI key is pressed down while the PTT key is also pressed and held. The initial frequency of the tone signal is 1750Hz, and it can be changed it in the Setting mode.(Page 30)
- CTCSS Tone frequency or DCS code is added and transmitted automatically when the Tone / DCS is set. You must select a tone or code that matches the tone or code monitored by the receiving station, if that station is using a tone or code squelch.(Page 24)

## 5.4 Channel Names

Channel names can be set and displayed instead of the frequency indication in the Memory mode.

You can assign names to the memory and call channels. There are 67 characters available such as A ~ Z and 0 ~ 9 for programmed memory channel names.

### ■ Setting



1. Select a channel you wish to name in the Memory mode.
2. Press the  key and the  key while  appears. "A" appears and blinks on the display.
3. Select a character by rotating the dial.
4. Press the  key to set. The selected character stops blinking. The same character blinks on the right side of the completed character to indicate it can now be selected.
5. Set characters one by one, up to a total of six.
6. If the  key is pressed during the name setting procedure, all the selected characters are cleared.
7. Press a key other than the MONI,  and the  keys to complete the setting and to return to the usual display.

### ■ Channel Name Display

- In the Memory mode, programmed channel names are displayed instead of the frequency display. (Channel numbers are displayed whether or not the channel names are programmed.)
- Frequency display appears for 5 seconds by pressing the  key. If a key is pressed during the 5-second frequency display, the display returns to the channel name indication or moves to a function setting mode depending on the pressed key.

## 5.1 Lamp

DJ-596 has lamps to light its display and keyboard. Press the  key and then the MONI key while **F** appears to light the lamps.

- The lamps turn off automatically if no key is pressed for 5 seconds.
- If a key other than the LAMP key is pressed while the lamps light, the lamps remain on for another 5 seconds.
- To light the lamps continuously, press and hold the MONI key and turn the power ON.
- To cancel continuous lighting, turn the power OFF, press and hold the MONI key and turn the power ON again.
- To turn off continuous lighting, press the  key and the MONI key while **F** appears.  
To light the lamps again, press the  key and the MONI key while **F** appears.





# 6. Communicating

## Select Communicating



- When communicating with a specific station, the tone squelch function or DCS function may be used.  
Tone squelch is a function that unmutes the squelch and enables you to receive a partner's signal when the tone frequency matches a tone you selected from one of your station's 39 tone frequencies.
- DCS is a function that unmutes the squelch and enables reception of the partner's signal when the digital code matches a code you selected from one of your station's 104 digital codes.
- Tone squelch and DCS cannot be used at the same time.

## 6.1 Tone Squelch

### ■ Tone Squelch Setting

- Press the  key and the  key while  appears. Present mode and tone frequency are displayed, and the setting rotates as below each time the  key is pressed.

T            T/SQ  
88.5 → 88.5 → TCS-OFF  
↑

-  indicates that only the encoder function is set.
-  indicate that the encoder /decoder functions (tone squelch) are set.
- Monitoring can be performed when the tone frequency is being displayed.

- Rotate the dial to select a tone frequency from the 39 kinds of frequencies below.

67.0	69.3	71.9	74.4	77.0	79.7	82.5	85.4	88.5	91.5
94.8	97.4	100.0	103.5	107.2	110.9	114.8	118.8	123.0	127.3
131.8	136.5	141.3	146.2	151.4	156.7	162.2	167.9	173.8	179.9
186.2	192.8	203.5	210.7	218.1	225.7	233.6	241.8	250.3(Hz)	

- Press a key other than the MONI key to complete the setting.



### ■ Canceling Tone Squelch

Select "TCS-OFF" in the tone squelch setting mode by pressing the  key.

Press a key other than the MONI key to complete the tone squelch cancellation.

### ■ Changing Tone Squelch Frequency

Tone encoder frequency and tone decoder frequency can be set independently.

- If the encoder frequency is changed when  is displayed, the decoder frequency is automatically changed to the same frequency.
- If the frequency is changed when  is displayed, only the decoder frequency is changed. (Different frequencies are set respectively to encoder /decoder.)



## 6.2 DCS (Digital Code Squelch)

### ■ DCS Setting

Press the  key and the  key while  appears.

DCS and the DCS code are displayed.

Initial setting is "023".

DCS  
023 → DCS-OFF  
↑

Press a key other than the MONI key to complete the setting.

### ■ Changing DCS Code

1. Set the DCS code in the DCS code setting mode. (The status where **DCS** appears.)
2. Change the DCS code by rotating the dial, and press a key other than the MONI key to complete the setting.  
The same DCS code is set to both encoder / decoder.

The following 104 DCS codes can be selected.

023	025	026	031	032	036	043	047	051	053
054	065	071	072	073	074	114	115	116	122
125	131	132	134	143	145	152	155	156	162
165	172	174	205	212	223	225	226	243	244
245	246	251	252	255	261	263	265	266	271
274	306	311	315	325	331	332	343	346	351
356	364	365	371	411	412	413	423	431	432
445	446	452	454	455	462	464	465	466	503
506	513	523	526	532	546	565	606	612	624
627	631	632	654	662	664	703	712	723	731
732	734	743	754						

### ■ Canceling DCS







To cancel DCS, select "DCS-OFF" by pressing the  key, and press a key other than the MONI key to complete the setting.

### ■ DCS Operation

Squelch unmutes when the receiving code matches the programmed DCS code.

- Reference
- Changing DET Operation of DCS  
The Squelch may accidentally close in the DCS setting depending on the level of modulation received from the transmitting side. In this case, it may be necessary to select "DCS-OFF" and rotate the dial to change the display to "DCS OF", and then set DCS. (This setting is written to memories.)

## 6.3 DTMF Manual Transmitting

When one of the 16 keys ( ~ ,  ~ , , ) is pressed during transmission, a DTMF code corresponding to the pressed key is transmitted. DTMF codes that are transmitted manually are automatically recorded, up to 16 entries, and can be redialed in the same fashion as the auto dialer.



1. Press and hold the PTT key and press one of the 16 keys.
2. A DTMF code corresponding to the pressed key is transmitted.

## 6.4 Auto Dialer







This function is to set DTMF codes to the DTMF memory.

### ■ Auto Dialer Memory Setting

Program DTMF codes you want to transmit using the auto dialer function.





1. Press the  key and the  key while  appears. The auto dialer programming mode is activated. 6 figures are displayed. No display appears in the initial status.
2. Select a dialer memory number from No.1 ~ 9 by rotating the dial.  
Input the codes by pressing the 16 keys. The display indication will be as follows.

3. For example, if you input 123456789, the display will be:  
「1」 → 「12」 → 「123」 → 「1234」 →  
「12345」 → 「123456」 → 「234567」 →  
「345678」 → 「456789」  
You can input up to 16 entries.



- A pause can be set instead of codes by pressing the  key and the  key while  appears. A pause is displayed as “\_”, and no signal is sent for approx. 1 second.
- The display can be scrolled within the entered range by pressing the  key and rotating the dial.
- To clear the entered codes, press the  key and the  key while  appears.

4. Press the PTT key to complete the setting.

## ■ Auto Dialer Output







1. In the receive mode, press the  key and press the  key while  appears. "DIAL" is displayed.
2. By pressing one of the  ~  keys, DTMF codes that are programmed into the autodialer memory number of the pressed key are automatically played back through the speaker.
  - The DTMF tones are not transmitted in this operation.
  - If DTMF codes are not programmed into the memory number of the pressed key, no DTMF codes are heard.

## ● Transmitting DTMF codes from the Auto Dialer

1. Press the PTT key to transmit, and press the  key while the PTT key is being held. "DIAL" appears on the display.
2. Press one of the  ~  key to transmit the programmed DTMF codes. If DTMF codes are not programmed into the memory number of the pressed key, no DTMF codes are transmitted.

## ■ Redialing

This function is to retrieve the last outputted DTMF codes.



1. In the receiving mode, press the  key and the  key while  appears. "DIAL" appears on the display.
2. The most recently used DTMF codes (either one of the auto dialer codes or manually transmitted DTMF codes) are automatically heard from the speaker by pressing the  key. The signals are not transmitted in this operation.
3. To transmit the most recently used DTMF codes, press and hold the PTT key, and then press the  key and the  key. While they are being transmitted, the DTMF codes are also heard from the speaker during this operation.

**Note** The redial function is not active in the default factory settings or after resetting. It is also not available when no DTMF output has been done.

## 6.5 TOT (Timeout Timer)

This function automatically stops transmission when a specified period of time has been exceeded.

### Setting

1. Press the  key and the  key while  appears. "TP-OFF" is displayed.

2. Rotate the dial to adjust the TOT setting time.

The maximum setting time is 450 seconds.

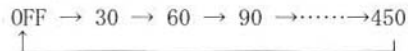

### TOT Operation

When transmitting continues up to the TOT setting time, a beep is heard 5 seconds before the time-out. When the transmission exceeds the set TOT value, the transceiver automatically stops transmitting and shifts to receive status. In order to transmit again, release the PTT key once and then press it again.



If a TOT penalty is set, transmitting is not available within the penalty period even if the PTT key is pressed again.

Note: A warning beep will not be heard if the Beep setting is set to OFF.

## 6.6 APO (Auto Power Off)

This function prevents wasting battery power when you forget to turn off the transceiver.

### Setting

Press the  key and the  key while  appears. APO is displayed.

### APO Operation

If there is no operation for 30 minutes when APO is on, a beep is heard and the power goes off automatically.



To turn on the power again, press the power switch.

Note APO time is not extended, even if a signal is received. It is extended only when a key operation is performed.

## 6.7 BELL

The bell informs you that a signal is being received.

### Setting

1. Press the  key and the  key while  appears. "BEL-OFF" is displayed.

2. Select "BEL-ON" by rotating the dial, and Press the  key or the PTT key to complete the setting.

### BELL Operation

When a signal is received, the "BELL" blinks and a bell sound is heard. The Bell function turns off when a key is pressed.

To cancel the bell function, repeat select "BEL-OFF" in the above procedure 1, 2, and press the FUNC key or the PTT key to complete the setting.

# 7. Parameter Setting mode



In the setting mode, you can adjust various operating parameters of the DJ-596.

## 7.1 Mode Setting Items

The following items can be addressed in the Setting mode.

- Battery Save function
- Scan Type
- BEEP Sound
- Tone Call Frequency
- Busy Channel Lockout
- TOT Penalty
- DTMF Wait Time
- DTMF Burst/Pause (DP) Time
- DTMF First Digit Burst Time
- Theft Alarm Function
- External Terminal Control Function
- Mosquito Repelling Signal
- End Peep

## 7.2 Selecting the Setting Mode

1. Hold  key down for a few seconds and the Setting mode is activated.  
The initial menu displays “BS-ON”.
2. You can review the menu by pressing the MONI key (upward) or  (downward).  
Monitoring will not occur in this mode.
3. Rotate the dial and change the appropriate settings.
4. Press a key other than the  and MONI keys to complete the setting and to return to the transceiver's normal status.  
The last menu item operated appears the next time the setting mode is activated.

## 7.3 Setting the Parameters

In the Setting mode, you can set the following functions:  
(Each function is described below.)

### ■ Battery Save

The battery save function extends battery life. If there is no key operation and no signal reception for five seconds, the internal power of the transceiver cycles on and off in a fixed ratio to reduce battery power consumption.

1. "BS-ON" is displayed in the Battery Save setting menu.
2. Rotate the dial to turn ON/OFF the battery save function.

BS-ON → BS-OFF  
↑

- It is "On" in the initial factory settings.
- This operation is cancelled temporarily if a signal is received or another operation is performed.

### ■ Scan Type

Timed scan and busy channel scan can be selected in the Setting mode.

1. "TIMER" is displayed in the Scan Type switching menu.
2. Rotate the dial to change the scan type. The display rotates as follows.

TIMER → BUSY  
↑

### ■ Beep

It is the function to make a beep sound when operating.

1. "BEP-ON" is displayed in the Beep function setting menu.
2. Rotate the dial to turn ON/OFF the beep function. The display rotates as follows.

BEP-ON → BEP-OFF  
↑

### ■ Tone Call Frequency

1. "1750" is displayed in the Tone Call Frequency setting menu.
2. Rotate the dial to change the frequency. The display rotates as follows.

1750 → 2100 → CALL → 1000 → 1450  
↑

3. The CALL tone transmits a ringing sound similar to that of a telephone.

## ■ BCLO (Busy Channel Lock Out)

When active, the ability to transmit is restricted if signals are being received.

1. "BCL-OFF" is displayed in the BCLO setting menu.
2. Rotate the dial to turn ON/OFF the BCLO function. The display rotates as follows.

BCL-OFF → BCL-ON  
↑  
└──────────────────┘

When BCLO is on, transmitting is available only if a signal is not being received.

If you press the PTT key when transmitting is not available, an alarm goes off to indicate that you cannot transmit. The alarm will not be heard if the BEEP parameter is set to OFF.

## ■ TOT Penalty

When the TOT penalty is set, transmission is not allowed within the programmed TOT penalty time after a transmission is automatically stopped by TOT.

1. "TP-OFF" is displayed in the TOT Penalty setting menu.
2. Rotate the dial to change the TOT penalty time (seconds). The display rotates as follows.

TP-OFF → TP-1 → ..... → TP-4 → ..... → TP-15  
↑  
└──┘

- When PTT key is pressed during TOT penalty time, an alarm goes off.  
The alarm will not be heard if the BEEP parameter is set to OFF.
- When PTT key is pressed after the TOT penalty time finishes, the penalty operation is cancelled and you can transmit again.

## ■ DTMF Wait Time

When the auto dialer outputs programmed DTMF codes, the codes are sent after the programmed DTMF wait time. The default setting is 100mS.

1. "DWT-01" is displayed in the DTMF Wait Time setting menu.
2. Rotate the dial to change the DTMF Wait Time. The display rotates as follows.

DWT-01 → DWT-04 → DWT-07 → DWT-10

## ■ DTMF Burst/Pause Time

When the auto dialer outputs programmed DTMF codes, the codes are sent according to the programmed burst/pause time. The default setting is 60mS.

1. "P-60" is displayed in the DTMF Burst/Pause Time setting menu.
2. Rotate the dial to change the Burst/Pause Time. The display rotates as follows.

DP-60 → DP-80 → DP-160 → DP-200

## ■ DTMF First Digit Burst Time

When the auto dialer sends programmed DTMF codes, the first code is sent according to the programmed DTMF First Digit Burst Time. The default setting is 60mS.

1. "DB-60" is displayed in the DTMF First Digit Burst Time setting menu.
2. Rotate the dial to change the DTMF First Digit Burst Time. The display rotates as follows.

DB-60 → DB-80 → DB-160 → DB-200

Reference DTMF times are as follows.

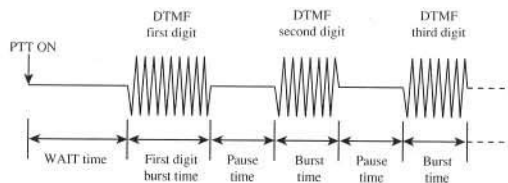

## ■ Theft Alarm

DJ-596 has a theft alarm function that generates an alarm sound from the speaker if the alarm cable is removed improperly. When the plug of the 3.5  $\phi$  alarm cable connected to the SP terminal of the transceiver (as shown in the illustration) is pulled out, an alarm sounds from the speaker.

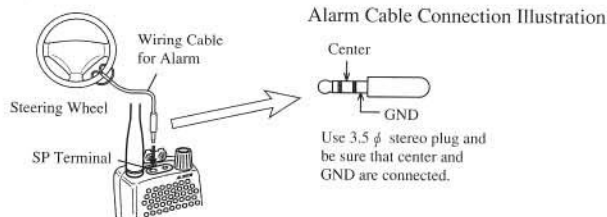

1. Turn off the power of the transceiver and insert the alarm cable plug in the SP terminal.
2. Turn on the power of the transceiver and select "SCR-OF" in the Setting mode.
3. Rotate the dial to turn ON/OFF the Theft Alarm function. The display rotates as follows.

「\*」appears  
SCR-OF → SCR-ON



4. Complete the setting and press the  key to turn off the power.

The theft alarm function works in this status.

5. When the plug is pulled out or the cable is cut, the alarm starts sounding.

If the alarm operates accidentally, press and hold the MONI key and press the  key. The power is turned off.

6. If memory channel 99 is programmed, the transceiver receives the programmed frequency while in the alarm mode.

If the memory channel 99 is blank, the transceiver receives the previous frequency that was selected before turning off the power.

When the squelch is unmuted, the alarm stops and the transceiver receives the signal as usual.

**Note** Set the squelch beforehand to close when no signal is received at the receiving channel. It is recommended to use tone or DCS squelch together with regular squelch so that the alarm is not cancelled accidentally by an unnecessary signal.

## External Terminal Control

5V is output from the MIC jack when the speaker is on.

1. Select "EXP-ON" in the setting mode.  
100MHz decimal point "." appears on the display.

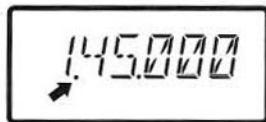

2. When a signal is received (when tone/code matches if TSQ/DCS is set), DC5V(5mA MAX) is output from the central terminal of the MIC stereo jack.
3. To cancel the External Terminal Control, select "EXP-OFF" in the setting mode.  
When "EXP-ON" is selected, options which use MIC jack can not be used.

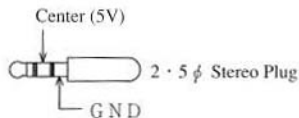

**Note** Be sure to use a 2 · 5 φ stereo plug or an internal short could occur, depleting the battery and possibly damaging the transceiver.

## ■ Mosquito Repelling Signal

An ultrasonic tone, which is disliked by some mosquitoes, is output from the speaker.

1. Select "MRS-ON" in the setting mode.

An ultrasonic tone is sent from the speaker.

- The transceiver operates normally even when MRS is on.
- Since the ultrasonic tone is always present if MRS is on, the usable time of the battery is reduced.
- To cancel the MRS setting, select "MRS-OFF" in the setting mode.

Note There are thousands of kinds of mosquitoes in the world. Since some of them may not dislike the ultrasonic wave output from this transceiver, it may be ineffective against them. No warranty is made as to the effectiveness of this experimental feature.

## ■ End Peep

You can add a "peep" sound at the end of the transmission to inform your partner that you have released the PTT.

1. "EDP-OFF" is displayed in the End Peep setting menu.
2. Rotate the dial to turn ON/OFF the end peep. The display rotates as follows.

EDP-OFF → EDP-ON  
↑

"OFF" is set in the initial factory setting.

# 8. Cloning and Packet Operation

## 8.1 Cloning

In using the cloning function, all of the information (including settings and memory data) of one DJ-596 (master) can be transferred and copied to another DJ-596 (slave) by connecting them with a cable.

### ■ Connecting the Transceivers

- Connect the external speaker jacks on both the master and slave transceivers with a commercially available 3.5  $\phi$  stereo mini plug cord.
- Turn off the power when connecting the cable.

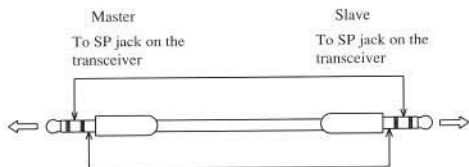

- Turn on the power of both transceivers after making the connections.

### ■ Transmitting Data from the Master Transceiver

1. Press and hold the MONI key and press the PTT key 3 times. "CLONE" appears on the display to indicate the Clone mode is activated.



2. Press the PTT key. "SD \*\*\*" is displayed. Information is now being transferred to the other transceiver.



3. "PASS" appears when the cloning function is completed.

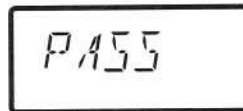

4. If the power is turned off, the cloning mode is cancelled. If the data is not transmitted correctly, "PASS" is not displayed. Repeat the process described in steps 1 and 2.

### ■ Receiving the Master Data

1. When the master data is transmitted, "LD \*\*\*" appears on the slave transceiver's display.

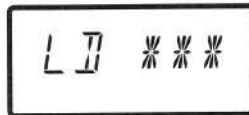

Note The cloning cable is not available as an optional accessory. Please make it by yourself

2. "PASS" appears when the cloning is completed.

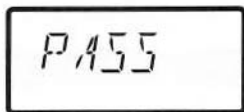

3. Turn off the power.

If the data is not transmitted correctly, "PASS" is not displayed.

In this case, try to transmit the master data again or reset the slave transceiver.

If "PASS" did not appear after cloning, incorrect operation may occur if you attempt to use the slave transceiver.

- Note
- Use a direct connection type cable without internal resistance.
  - If any key is pressed while data is being transmitted during the cloning operation, the cloning transmission stops. Press the PTT key to start transmitting again.
  - Do not disconnect the cable while cloning. If the cable is pulled out, "COMERR" appears on the master transceiver's display, and the data transmission stops.
  - All data in the slave transceiver will be updated to the master transceiver's data by the cloning operation. Be sure you want to change everything before cloning.

## 8.2 Packet Operation

Packet operation is one of the data communication methods, which enables data transmission and reception with a personal computer and TNC.

### ■ Packet Operation Connections

Packet operation connections for this unit are shown below.

Connect the packet communication TNC (Accessory: Terminal Node Controller) terminals to the SP ( $\phi$  3.5 mm plug) and MIC ( $\phi$  2.5 mm plug) connectors at the top of the transceiver.

- Input level adjustment :The transceiver has no MIC level adjustment circuit. Adjust the output level of the TNC.
- Output level adjustment : Use the volume dial of the transceiver.

### ● Connection method for packet operation

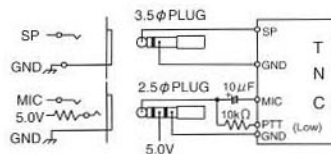

Power can be supplied from an internal 5V source through a 100  $\Omega$  resistor.

- Note
- Refer to the TNC'S instruction manual when connecting the TNC unit to other devices (personal computer, etc.). If the transceiver, TNC and connected personal computer are too close together, noise between them may cause interference.
  - Turn the battery save function off during packet operation.
  - Confirm your frequency and your communicating partner's frequency. If the frequencies are not exactly the same, the number of retries will be high, or communications may not be possible at all.
  - Operate up to 1200 bps.

# 9. Maintenance and Reference



## 9.1 Troubleshooting

Please check the list below before concluding that the transceiver is faulty.  
If a problem persists, reset the transceiver. This may correct erroneous operation.

Symptom	Possible Cause	Action
Nothing appears on the display when you turn the power on.	Poor Ni-Cd battery pack or battery case connection.	Check if the battery pack terminals are clean.
	Dead battery.	Recharge or exchange batteries.
	You are releasing the key too quickly.	Hold the power switch down for 1 second.
No speaker audio. No reception.	Volume too low.	Adjust the volume.
	Squelch level too high.	Adjust the squelch.
	Tone squelch is on.	Turn off tone squelch.
	DCS is on.	Turn off DCS.
	You are pressing the PTT key and transmitting.	Release the PTT key.
Frequency display is incorrect.	CPU error.	Detach the battery pack or external power supply, wait 10 seconds and attach it again. If it is still not operational, reset the transceiver.
Won't scan.	Squelch is unmuted.	Set squelch so that noise is just muted.
Frequency and memory number do not change.	Keylock is on.	Turn off keylock.
	Transceiver is in the call mode.	Go to VFO mode.
Key entry not possible.	Keylock is on.	Turn off keylock.
One-touch repeater cannot be used.	Incorrect setting for one-touch repeater use.	Set the transceiver correctly for repeater use.
Cannot transmit. Display blinks or goes out when you transmit.	Battery power is insufficient.	Change or recharge batteries. Or connect transceiver to external power source.
Cannot transmit. No reply when you transmit.	Not pressing the PTT key firmly enough.	Press the PTT key firmly.
	You are outside of the band. (When shift is set.)	Transmit within transmission frequency range.
	Incorrect frequency.	Match your frequency to receiving station's frequency.
Display blinks or goes out when you receive.	Battery power is insufficient.	Change or recharge batteries.

## 9.2 Resetting

When you reset the transceiver, all settings are returned to the initial (default) factory settings.

1. Press and hold the  key and press the  key to turn the power on.
2. Release the keys when all segments are displayed.  
The transceiver returns to the initial VFO mode.

### ● Factory Settings

· VFO Frequency	VHF : 145,000MHz UHF : 445,000MHz (DJ-596T) UHF : 433,000MHz (DJ-596E)
· CALL Frequency	VHF : 145,000MHz UHF : 445,000MHz (DJ-596T) UHF : 433,000MHz (DJ-596E)
· Memory Channel	0 ~ 99ch Blank
· Shift, Tone, DSQ, APO, Keylock, Bell and Dial settings	OFF
· Shift Range	VHF : 0.6MHz UHF : 5.0MHz
· Tone Frequency	88.5Hz
· Tuning Step	DJ-596T : 5KH z DJ-596E : 12.5KH z
· Audio Volume	0
· Squelch Level	0
· Scan Resume Condition	Timed Scan
· Transmit Power	LOW
· Battery Save	ON
· Beep	ON
· DTMF-WAIT Time	100ms
· DTMF Burst/Pause Time	60ms
· DTMF 1st figure Burst Time	60ms

## 9.3 Options

EBP-50N	Ni-MH Battery Pack (DC9.6V700mAh)
EBP-51N	Ni-MH Battery Pack (DC9.6V1500mAh)
EDH-30	Battery Case
EDC-36	Cigarette lighter cable with filter (DC12V)
EDC-37	DC cable for base station (DC12V)
EDC-43	Cigarette lighter cable for recharging
EDC-97	Rapid recharger
EDC-93	Battery recharger (120V / AC input)
EDC-94	Battery recharger (230V / AC input)
EMS-9	Speaker microphone
EMS-47	Speaker microphone with volume-control
EME-6	Earphone
EME-12	Head set with VOX (headphone type)
EME-13	Head set with VOX (inner type)
EME-15	Tie-pin microphone with VOX
EME-17	Earphone microphone
EME-20	Earphone microphone
ESC-36	Softcase

## 9.4 Transmission System

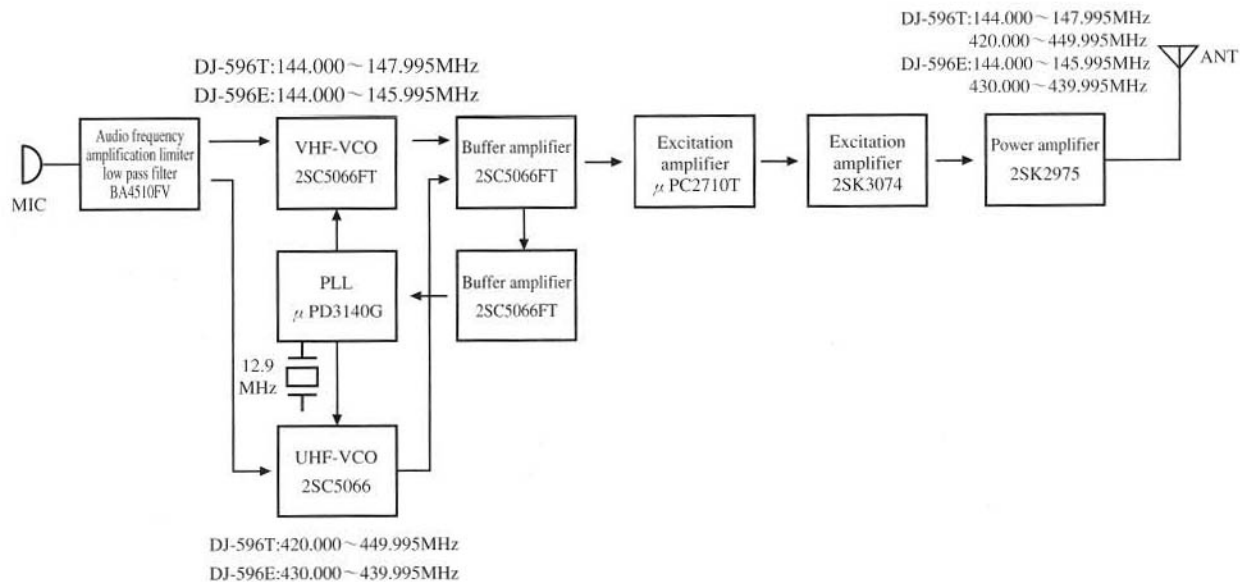

# 10. Specifications

## ● General

Frequency Range	VHF	144.000 ~ 147.995MHz (DJ-596T)
		144.000 ~ 145.995MHz (DJ-596E)
	UHF	420.000 ~ 449.995MHz (DJ-596T)
		430.000 ~ 439.995MHz (DJ-596E)
Modulation		F2, F3
Ant. Impedance		50 Ω (BNC)
Supply Voltage	External Terminal	6.0 ~ 16.0VDC
	Battery Terminal	6.0 ~ 16.0VDC
Current	Transmit	DC13.8V : VHF Approx.1.2A, UHF Approx.1.4A 9.6V(EBP-50N) : VHF Approx.1.2A, UHF Approx.1.5A
	Receive	Approx. 75mA
	Battery Save	Approx. 25mA
Frequency Stability		±5ppm
Dimensions	(Projections exclusive)	56(W) × 124(H) × 40(D)mm
Weight		Approx. 280g (EBP50N inclusive)

## ● Transmitter

Power Output	External 13.8V	Approx. 5W
	EBP-50N equipped	VHF : 4.5W, UHF : 4W
Modulation		Variable Reactance
Max. Deviation		±5kHz
Spurious Emission		-60dB or less
Mic. Impedance		Approx. 2k Ω

## ● Receiver

System		Double-conversion super heterodyne
Intermediate Frequencies	1st	LF 39.15MHz
	2nd	IF 450kHz
Sensitivity	(12dB SINAD)	-15.0dB μ or less
Selectivity	-6dB	±6kHz or over
	-60dB	±15kHz or less
AF Output		300mW or over (MAX) 200mW or over (10% Distortion factor 8 Ω)
Spurious response		60dB or over
Squelch Sensitivity		Approx. -10dB μ or less



# ALINCO, INC.

Head Office: Shin-Dai building 9<sup>th</sup> Floor  
2-6, 1-Chome, Dojimahama, Kita-ku,  
Osaka 530-0004, Japan

Phone: +81-6-4797-2136

Fax: +81-6-4797-2157