

 **KENWOOD**

**2m FM TRANSCEIVER**

**Model TR-7730**



**INSTRUCTION MANUAL**

# INTRODUCTION

You are the owner of our latest product, the new TR-7730 transceiver. Please read this instruction manual carefully before placing your transceiver in service. The unit has been carefully engineered and manufactured to rigid quality standards, and should give you satisfactory and dependable operation for many years.

## AFTER UNPACKING

- Shipping container:  
Save the boxes and packing in the event your unit needs to be transported for remote operation, maintenance, or service.
- The following explicit definitions apply in this manual:  
**Note:** If disregarded, inconvenience only, no risk of equipment damage or personal injury.  
**Caution:** Equipment damage may occur, but not personal injury.

## CONTENTS

FEATURES .....	3
BEFORE USE .....	3
SPECIFICATIONS .....	4
SECTION 1. PREPARATION FOR USE	
1.1 Installation.....	5
SECTION 2. CONTROLS AND TERMINALS	
2.1 Front panel .....	8
2.2 Rear panel .....	10
SECTION 3. OPERATION .....	11
3.1 Transmitter precautions .....	11
3.2 Frequency selection .....	11
3.3 Priority of controls.....	11
3.4 Memory switch .....	11
3.5 Scan operation .....	12
3.6 TX Offset switch .....	12
3.7 Squelch.....	12
3.8 HI/LOW switch.....	12
3.9 Autopatch operation.....	12
3.10 TONE switch.....	13
3.11 Bail and Foot Installation.....	13
3.12 Adjustments .....	13
SECTION 4. ADDITIONAL INFORMATION.....	14
SECTION 5. OPTIONAL ACCESSORIES .....	14
SCHEMATIC DIAGRAMS .....	15
BLOCK DIAGRAMS .....	16

## ACCESSORIES

Carefully unpack your TR-7730 and check that it is supplied with the following accessories:

- 1 Dynamic microphone (with U/D switch) (T90-0313-05)..... 1 piece
- 2 Mounting bracket (A13-0618-22)..... 1 piece  
Mounting boss (J32-0748-04) ..... 4 pieces  
Machine screw (3 $\phi$  x 6) ..... 6 pieces  
Machine screw (3 $\phi$  x 12) ..... 4 pieces  
Pan head screw (6 $\phi$  x 8)..... 4 pieces  
Flat washer (6 $\phi$ ) ..... 4 pieces  
Spring washer (6 $\phi$ )..... 4 pieces  
Flange nut (6 $\phi$ ) ..... 4 pieces  
(For installation, see page 6 and 13)
- 3 Leg  
Front bail (J02-0420-04)..... 1 piece  
Bail mounting hardware (J21-2676-04) ..... 2 pieces  
Rear foot (J02-0022-05)..... 2 pieces
- 4 DC power cord (E30-1689-05) ..... 1 piece
- 5 Fuse (6A) (F05-6021-05)..... 1 piece
- 6 Miniature plug (for external speaker) (E12-0001-05)..... 1 piece

# FEATURES

1. Compact and lightweight design.
2. Rotary encoder, 5 kHz or 10 kHz-step digital VFO system specifically designed for mobile operation.
3. High sensitivity, RF amplifier using a low noise dual gate MOS FET.
4. PLL circuit for direct VCO (Voltage Controlled Oscillator) output at 144 MHz assures excellent spurious characteristic.
5. BUSY and MEMORY scan functions stop scan operation when a signal is present.
6. Five memory channels. Two different frequencies (transmit and receive) are stored in CH5, permitting "odd-split" repeater operation.
7. Hand microphone with UP-DOWN switch.
8. TX OFFSET Switch shifts frequencies  $\pm 600$  kHz for standard repeater operation.
9. RF POWER HI(25 W) – LOW (5 W) select switch.
10. Red LED frequency display.
11. S and RF METER LED bar indicator.
12. External BACK UP terminal.
13. Extended frequency coverage (143.900 ~ 148.995 MHz) in switchable 5 kHz or 10 kHz steps, allowing simplex and repeater operation on many MARS frequencies.

# BEFORE USE

**KEEP  
OUT**



**Do not adjust coils, trimmers, or pots!  
These are factory adjustments.**



**This unit is designed for 12 V, negative ground ONLY.**

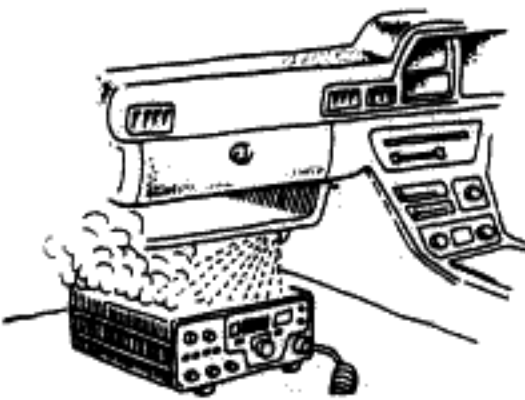

**Do not install near heater outlet.**



**After parking in the sun, and inside temperature is HOT,  
cool this unit BEFORE transmitting.**



**BEFORE connection, check polarity.**



**Keep equipment away from heat and out of direct sunlight.**

# SPECIFICATIONS

**[General]**

<b>Semiconductors</b> .....	ICs	15
	Transistors	46
	FETs	7
	Diodes	91
<b>Frequency range</b> .....	144.000 to 147.995 MHz	
<b>Frequency synthesizer</b> .....	Digital control, phase locked VCO	
<b>Mode</b> .....	FM (F3)	
<b>Antenna impedance</b> .....	50 ohms	
<b>Power requirement</b> .....	13.8 V DC $\pm$ 15%	
<b>Grounding</b> .....	Negative	
<b>Operating temperature</b> .....	- 20°C to + 60°C	
<b>Current drain</b> .....	0.4A in receive mode with no input signal 5.5A in HI transmit mode (Approx.) 3A in LOW transmit mode (Approx.) Less than 2.5 mA for memory back up (from power supply)	
<b>Dimensions</b> .....	147.5 mm (5-3/4") wide 51.5 mm (2") high 198.0 mm (7-3/4") deep (projections excluded)	
<b>Weight</b> .....	1.5 kg (3.3 lbs) (Approx.)	

**[Transmitter Section]**

<b>RF output power</b> (at 13.8 V DC, 50 $\Omega$ load) .....	HI 25 Watts min. LOW 5 Watts approx. (Adjustable)
<b>Modulation</b> .....	Variable reactance direct shift
<b>Frequency tolerance</b> (- 10°C ~ + 50°C) .....	Less than $\pm 20 \times 10^{-6}$
<b>Spurious radiation</b> .....	HI Less than - 60 dB LOW Less than - 53 dB
<b>Maximum frequency deviation (FM)</b> .....	$\pm 5$ kHz
<b>Microphone</b> .....	Dynamic microphone with PTT, up, down, switches, 500 $\Omega$

**[Receiver Section]**

<b>Circuitry</b> .....	Double conversion superheterodyne
<b>Intermediate frequency</b> .....	1st IF 10.7 MHz 2nd IF 455 kHz
<b>Receiver sensitivity</b> .....	Better than 0.5 $\mu$ V for 30 dB S/N Better than 0.25 $\mu$ V for 12 dB SINAD
<b>Receiver selectivity</b> .....	More than 12 kHz (- 6 dB) Less than 25 kHz (- 60 dB)
<b>Spurious response</b> .....	Better than 60 dB
<b>Squelch sensitivity</b> .....	0.16 $\mu$ V (threshold)
<b>Audio output</b> .....	More than 2.0 watts across 8 ohm load (10% dist.)

Note: Circuit and ratings are subject to change without notice due to developments in technology.

# SECTION 1. PREPARATION FOR USE

## 1.1 INSTALLATION

### 1.1.1. Interconnection

Connect the antenna and power supply as shown in Fig. 1-1 for fixed station or mobile operation.

### 1.1.2. MOBILE installation

#### ● Installation location

Using the supplied mounting bracket, install the transceiver under the dashboard or on the side of the console in your car. Refer to Fig. 1-2. Care should be taken to allow free circulation of air around the heat sink of the rear panel.

If your car is equipped with an electronic fuel injector, the transceiver should be as far from the control equipment as possible.

#### ● Antenna installation

Various types of antennas for 2 meters mobile operation are available.

#### NOTE:

For gutter-mount installation, the antenna bracket must be grounded to the car body as shown in Fig. 1-2. Affix the antenna securely, referring to the antenna instruction.

#### ● Power supply

Connect the supplied power cord with fuse directly to the battery terminals. Connecting to the cigarette lighter socket can cause a poor connection, and excessive voltage drop.

#### ● Back up power for micro-processor

With power supplied from battery, the micro-processor keeps operating even when the power switch is OFF. In this case, current drain is very low, approximately 2mA. The car can be parked overnight with little battery power consumed.

However, when the car is to be parked for a long period of time (more than 1 month), it is advisable to disconnect the power plug. In this case, the back up function is disabled.

If power is disconnected, the back-up function is retained for only 1 – 1.5 sec. If instantaneous voltage drop at engine-starting continues for more than 2 sec, the micro processor will be reset and the memory cleared.

#### ● Ignition noise

The transceiver is designed to suppress ignition noise; however, if excessive noise is present, it may be necessary to use suppressor spark plugs (with resistors).

NOTE: When first connecting the power cable (with the power switch off) the microprocessor may not be in standby mode. Backup current may be 2-3 times greater than normal, and the display decimal may flicker. Turn on the power to reset the microprocessor.

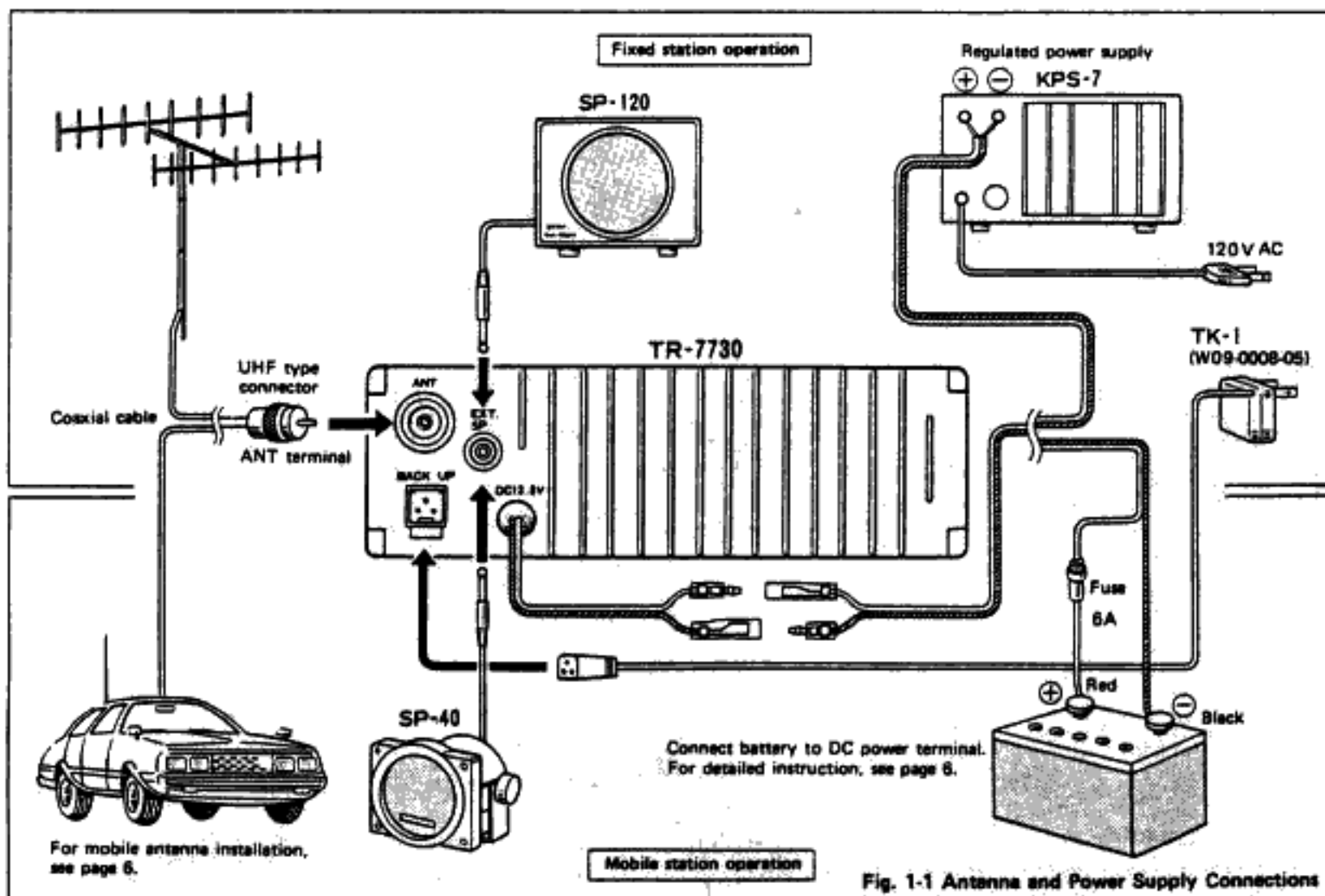

### 1.1.3. FIXED STATION Installation

#### ● Power supply

The KPS-7 power supply is available as an optional accessory and perfectly matches the design of your transceiver.

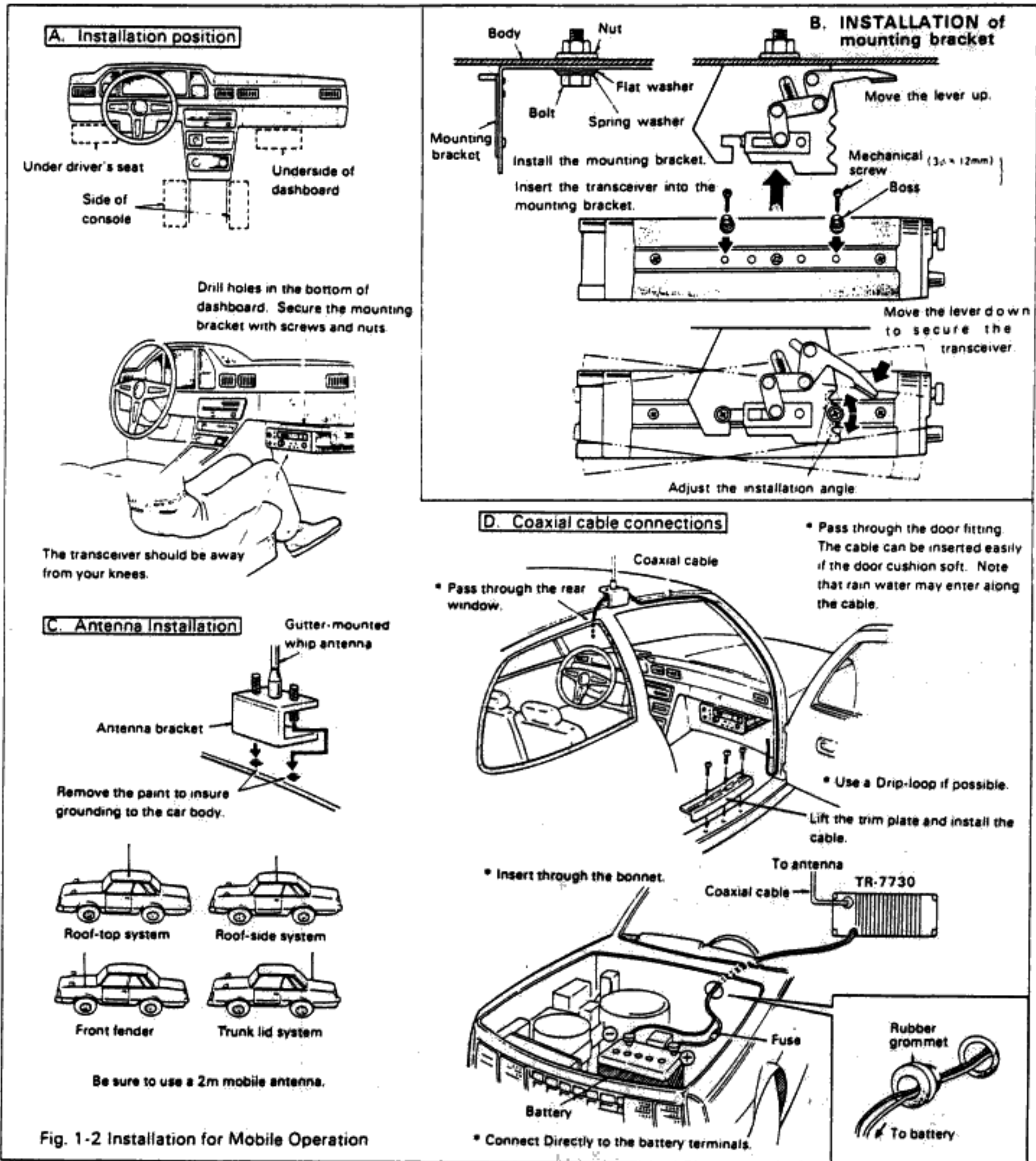

Fig. 1-2 Installation for Mobile Operation

### Antenna (Fig. 1-3)

Various types of fixed station antennas are commercially available. Select your antenna according to your installation space and application (DX, local QSO, etc.). Note that the SWR of your antenna should be less than 1.5. A high SWR will cause the TR-7730 protective circuit to operate, reducing the transmit output power. The TR-7730 is factory adjusted to deliver the rated RF output (25 W) at about 146 MHz, where the RF meter indicates "6" on the 10-division scale. The RF meter will indicate about this point when the antenna SWR is less than 1.5.

### Back-up Power for Micro-Processor (memory hold)

1. With power supplied directly from the KPS-7, the micro

processor continues operating even when the power switch is OFF.

Current drain is very low, approximately 2mA.

2. If you wish to retain the memories even when the KPS-7 is off, connect the (optional) TK-1 (W09-0008-05) to the external back-up terminal.

3. In usual VFO operation, the kHz digit can not be backed-up. However, this doesn't mean a malfunction. For instance, when the TR-7730 power switch is turned on after turned off at the operating frequency of 146.255 MHz, the operating frequency becomes 146.250 MHz.

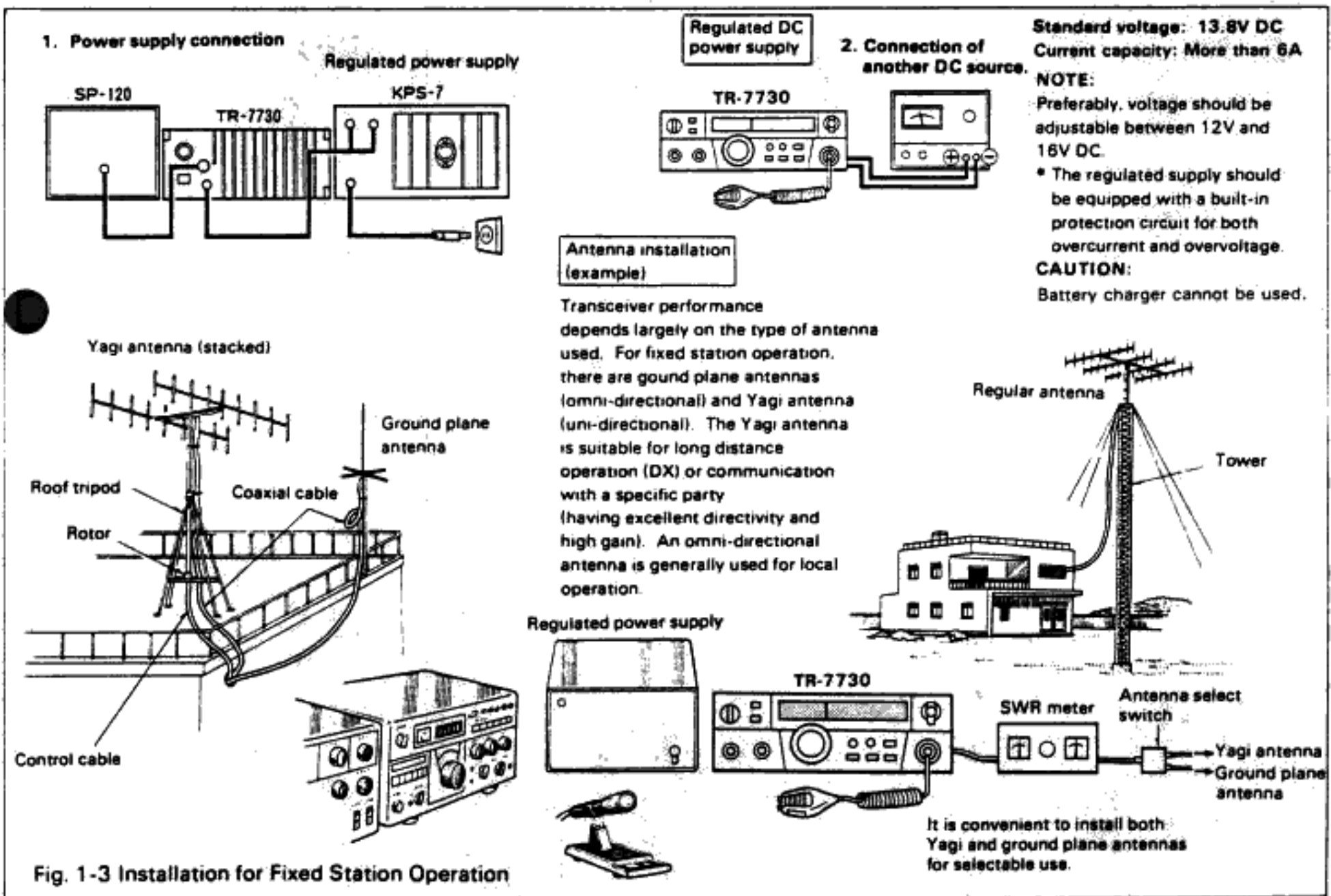

## SECTION 2. CONTROLS AND TERMINALS

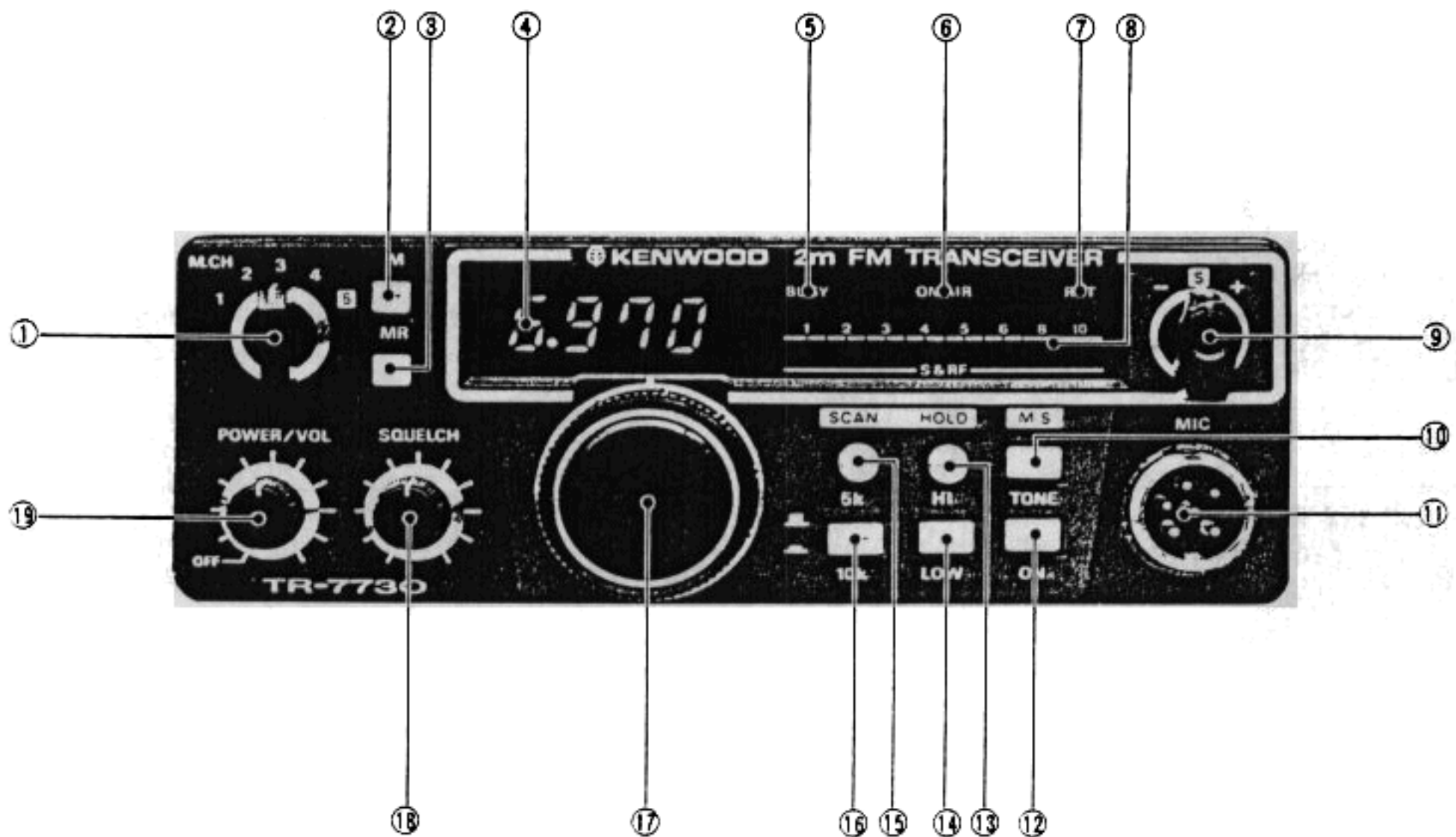

### 1. MEMORY selector

This switch is used to select memory channels "1" through "5". The operating frequency can be stored in or called back from the channel selected by this switch. In channel "5", two different frequencies (transmit and receive) can be stored for "odd-split" repeaters.

### 2. M switch

This is used to input desired frequencies to each channel for memory. By pressing (M) the switch, the frequency indicated on the display is stored in the selected channel.

### 3. MR switch

This is used to recall memory frequencies from each channel.

### 4. Frequency display

LEDs display the operating frequency in 4 digits (MHz - 1 kHz).

### 5. BUSY indicator

This lamp will light when the squelch is open in receive mode.

### 6. ON AIR indicator

A light emitting diode (L.E.D.) will light in the transmit mode.

### 7. RPT indicator

When the TX OFFSET switch is set to + or - position, this indicator lights.

### 8. S/RF-meter

This meter indicates receive input signal strength (S) or transmit output (RF).

### 9. TX OFFSET switch

Shifts the transmit frequency for repeater operation.

-: Switches the transmit frequency down 600 kHz from the receive frequency.

S: Simplex (receive and transmit frequencies are the same.)

+: Switches the transmit frequency up 600 kHz from the receive frequency.

### 10. M.S (MEMORY SCAN) switch

Press this switch and the memory channels 1 - 5 are scanned. The scan operation stops at a channel where signal is present. This switch should be used in conjunction with the SQUELCH control (see page 11).

### 11. MIC connector (6-pin)

For connection of the supplied microphone.



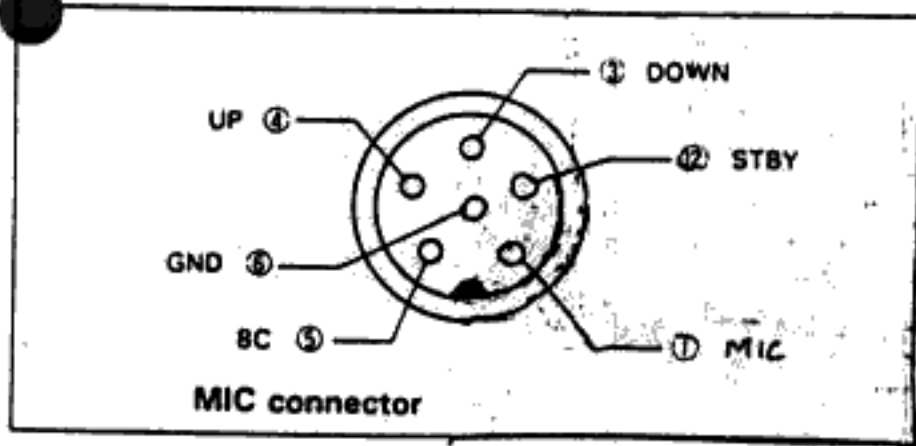

#### 12. TONE switch

The switch is for control of a user supplied tone generator (not available from TRIO-KENWOOD)

#### 13. HOLD switch

Pressing this switch releases scan operation or stops memory scan. The microphone PTT switch is also used to stop memory scan.

#### 14. HI/LOW switch

This switch is used to set transmit output power to either 25 W (high) or 5 W (low).

#### 15. SCAN switch

Using this switch, scan operation starts at the rate selected by the STEP switch, or the same as when you use the main dial. When a signal is present, scanning stops and the BUSY indicator lights.

The SCAN switch should be used in conjunction with the SQUELCH CONTROL and MEMORY SCAN switch (see page 11).

#### 16. STEP switch

Use this switch to select the step (■: 5 kHz, ▬: 10 kHz) during frequency scan or microphone UP/DOWN operation.

#### 17. Main Tuning

A click-type rotary digital VFO control selects transmit and receive frequencies. The frequency is changed in 5kHz or 10 kHz according to the step switch position. This digital VFO control is continuous, changing frequency from the upper to lower end of the band.

#### 18. Squelch

The squelch control is used to eliminate noise during no-signal time. Normally, this control is adjusted clockwise until the noise disappears and the BUSY indicator goes off (threshold level).

#### 19. POWER/VOL

Power ON-OFF switch and volume control are combined. Turning the control fully counterclockwise will turn the power OFF. Clockwise rotation will increase the volume. In the power OFF position, about 2mA current is drawn to back-up the micro-processor, provided the power cable is connected to a constant power source.

To completely disable the transceiver, disconnect the power cable.

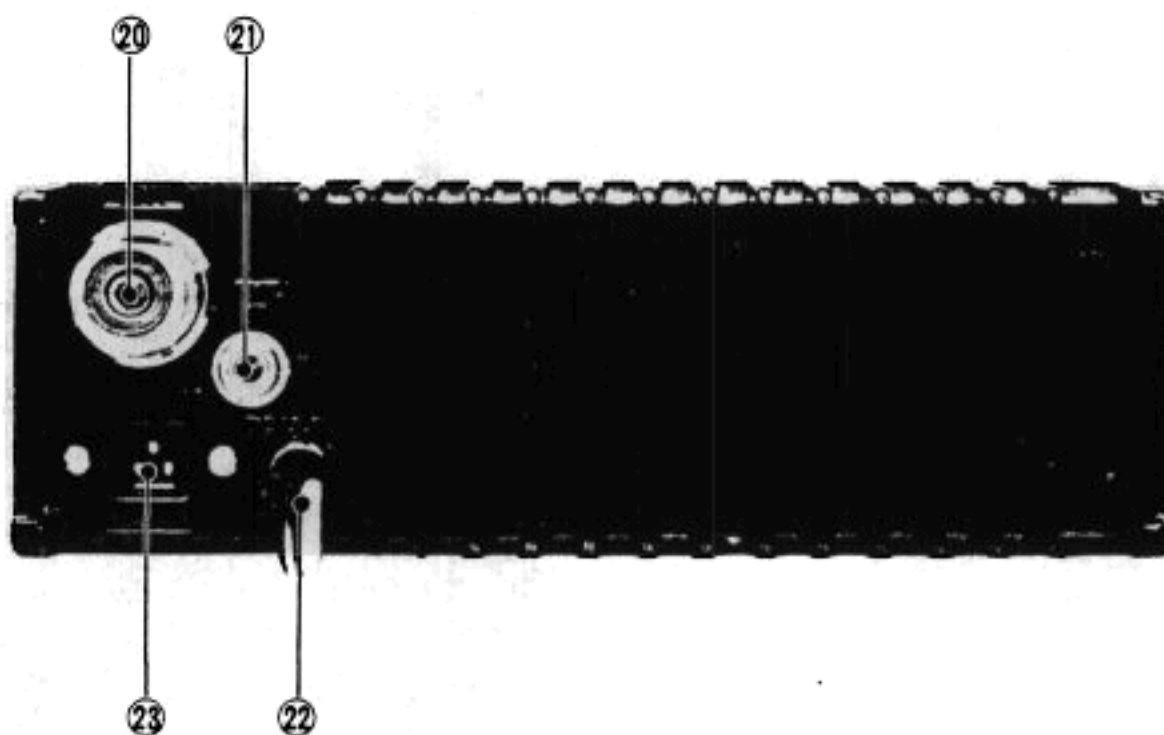

**20. ANT terminal**

Connect 50Ω for 2 m.

**21. EXT. SP terminal**

External speaker terminal. Connect a 8 ohm speaker using the supplied plug.

**22. DC power cord**

Connect the supplied power cord. Input voltage is 13.8V DC. Observe correct plus (+ : Red) and minus (- : Black) polarity.

**23. Back up power terminal**

This connector is used for back-up in fixed station operation. The micro-processor retains the VFO frequency memory function even when the power switch is turned OFF, when back-up power is supplied. Use optional TK-1 (W09-0008-05).

**24. PTT switch**

Press-to-talk switch used for transmission. This will also release scan operation.

**25. DWN switch**

This switch is used to step down the digital VFO frequency.

**26. UP switch**

This switch is used to step up the digital VFO frequency. When the DWN or UP switch is depressed continuously frequency shifts rapidly.

# SECTION 3. OPERATION

## 3.1 TRANSMITTER PRECAUTIONS

1. The TR-7730 antenna impedance is 50 ohms. Be sure to connect an antenna of 50 ohms impedance.
2. Check the transmit frequency before operating to insure that you do not interfere with other stations.
3. By pressing the microphone PTT switch. The TR-7730 is set in transmit mode; the ON AIR indicator will light and the meter indicates transmit power. Hold the microphone at about 5 cm when speaking.

## 3.2 FREQUENCY SELECTION

The TR-7730 uses a PLL synthesizer circuit controlled by micro-processor. The VFO frequency is shifted in 5 kHz or 10 kHz steps by turning the click-type main dial.

The main dial is a continuous rotary selector, changing frequency continuously from the upper to the lower end of the band. Operating frequencies are basically turned by the main dial. Turning the dial to the right will shift the frequency up, and vice versa.

The VFO frequency can also be step-tuned by the microphone UP/DOWN switch.

The VFO frequency shifts rapidly when the switch is continuously depressed.

## PRIORITY OF CONTROLS

1. since all the functions are controlled by a micro-processor, the transceiver must be operated in the priority order given in the following Table.

For example, the digital VFO will not operate when the main dial is turned during MR operation. Also, it will not operate unless scan operation is released by the HOLD switch or the microphone PTT switch, even if scan is stopped for a brief period of time in receive mode.

Sequence/Operation	Function	Switch or Controls
1	Memory recall	MR ON
2	Memory scan	MS ON
3	Scan operation	SCAN, HOLD ON
4	UP/DOWN operation	UP/DOWN ON
5	Digital VFO	Main dial
6	Memory Write	M ON

Fig. 3-1

2. The micro-processor is programmed to operate in receive mode, except one transmit frequency is also stored in memory channel "5". Note that the main dial and UP/DOWN controls do not function during transmission.

The digital VFO is factory adjusted under rigid quality standards to insure excellent frequency linearity and stability. Don't remove the PLL cover.

## 3.4 MEMORY SWITCH

Using this switch, commonly used frequencies (repeaters, etc.) can be stored in the memory. Frequencies set by the VFO are stored in channels 1 through 5 by using the M switch. Stored frequencies can be called-up by placing the MR switch ON.

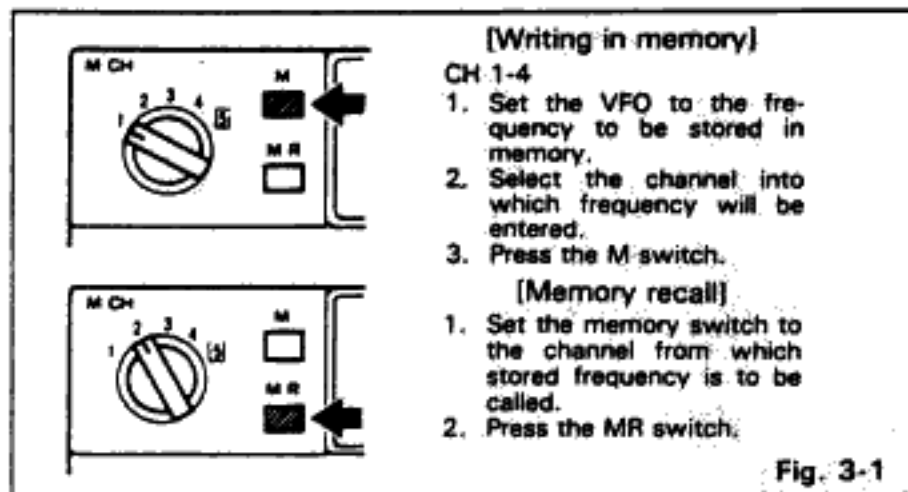

Two different frequencies (transmit and receive) can be stored in channel 5, so the transceiver will operate on any repeater split. The receiver frequency is stored in memory just as for channels 1-4. To store the transmit frequency in memory, set the transmit frequency in the receiver mode and then press the M switch in the transmit mode. (See Fig. 3-2)

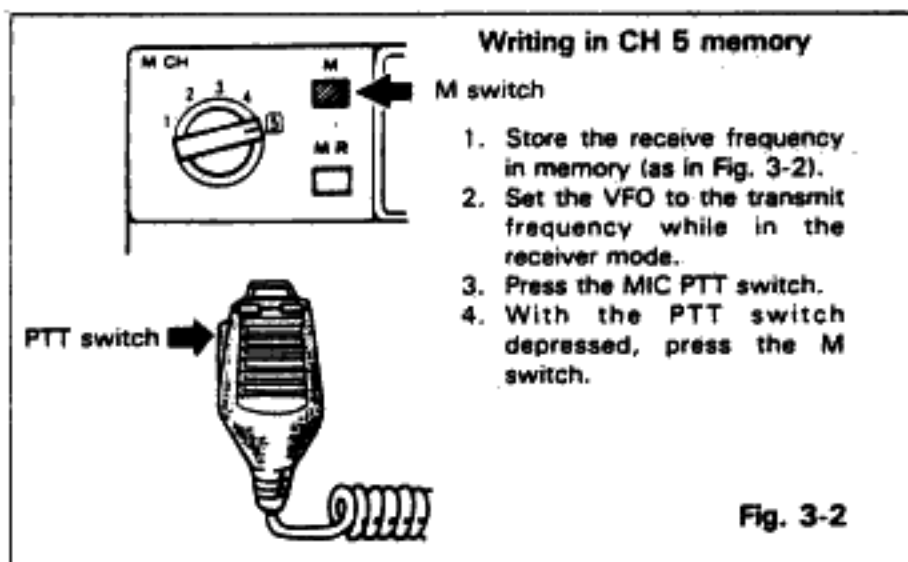

### [Note]

1. When a memory is vacant, the memory frequency is 144.000 MHz.
2. To clear a frequency stored in memory, simply store a new frequency in that memory channel. The frequency is also cleared by setting the power switch to OFF provided that the TR-7730 is not connected for backup operation.

## 3.5 SCAN OPERATION

The TR-7730 scan operation is classified into normal scan (scan stops at a signal and restarts when the signal is absent) and memory scan (CH 1 - 5 Receive).

#### \*Normal scan

1. Set the squelch control to the threshold point (noise disappears at no signal time and the BUSY indicator goes off).
2. Next, press the SCAN button to start scan operation.
3. When a signal is present, the scan stops. When the signal drops, scan restarts automatically.  
If you desire to restart the scan before the signal drops, press the SCAN switch once again.
4. If you desire to hold the frequency at which the scan stops, press the HOLD button or press the microphone PTT switch ON momentarily. Scan will be released and the transceiver will return to manual operation.
5. Scan speed is about 120 mS for each channel. When the scan button is continuously depressed, scan speed is doubled.

#### [Note]

1. During scan operation, including temporary scan stop, the frequency cannot be changed by the main dial or the microphone UP/DOWN switch. To change frequency, it is first necessary to release the scan by pressing the HOLD button or MIC PTT switch.
2. If the MR switch is pressed during scan operation, the memory frequency is output. When this switch is released, scanning will not resume and the transceiver is set in manual operation.
3. When scanning in 5 kHz step, scan may stop at the channel just before the channel where a signal arrives. In that case, depress the SCAN switch to tune the incoming signal.

#### \*Memory scan

1. Set the squelch control to the threshold point.
2. Next, press the MS switch ON to start scan operation of the memory channels 1-5. Frequencies are scanned the same as in normal scan operation.
3. To release the memory scan, set the MS switch to OFF. During memory scan operation, if you desire to hold the frequency at which the scan stops, press the HOLD button. If you wish to use any frequency other than the

memory frequency, the scan operation should be released by setting the MS switch to OFF.

### 3.6 TX OFFSET SWITCH

The TX OFFSET switch, used for selecting simplex or repeater operation, has three positions.

- + : The transmitter frequency is 600 kHz higher than the receiver frequency.
- S : The TR-7730 operates in the usual simplex mode. That is, receive and transmit frequencies are the same. This frequency is indicated on the digital frequency display.
- : The transmitter frequency is 600 kHz lower than the receiver frequency.

**NOTE:** \_\_\_\_\_  
OFFSET is available for both MEMORY CH and VFO operation.

### 3.7 SQUELCH

To eliminate the noise at no-signal condition turn the squelch slowly clockwise until the noise disappears and the BUSY lamp goes off (threshold point).

Adjust the VFO to an empty frequency. The BUSY lamp will light and the speaker will operate when a signal is received. The squelch control is also used for auto scan operation control.

If the signal is weak or fades during mobile operation, readjust the squelch for best operation.

### 3.8 HI/LOW SWITCH

For local FM communication, it is recommended that power be reduced to eliminate interference to other stations and to minimize power consumption. By pressing the HI/LOW switch, transmit power is reduced from 25 W to about 5 W, while the RF meter reading is about 2 or 3.

### 3.9 AUTOPATCH OPERATION

For autopatch operation, the optional autopatch microphone MC-46 is recommended.

## 0 TONE SWITCH

This switch is provided to control a user-supplied and installed tone encoder. TRIO-KENWOOD does not manufacture or supply this item. To install, refer to Fig. 3-3.

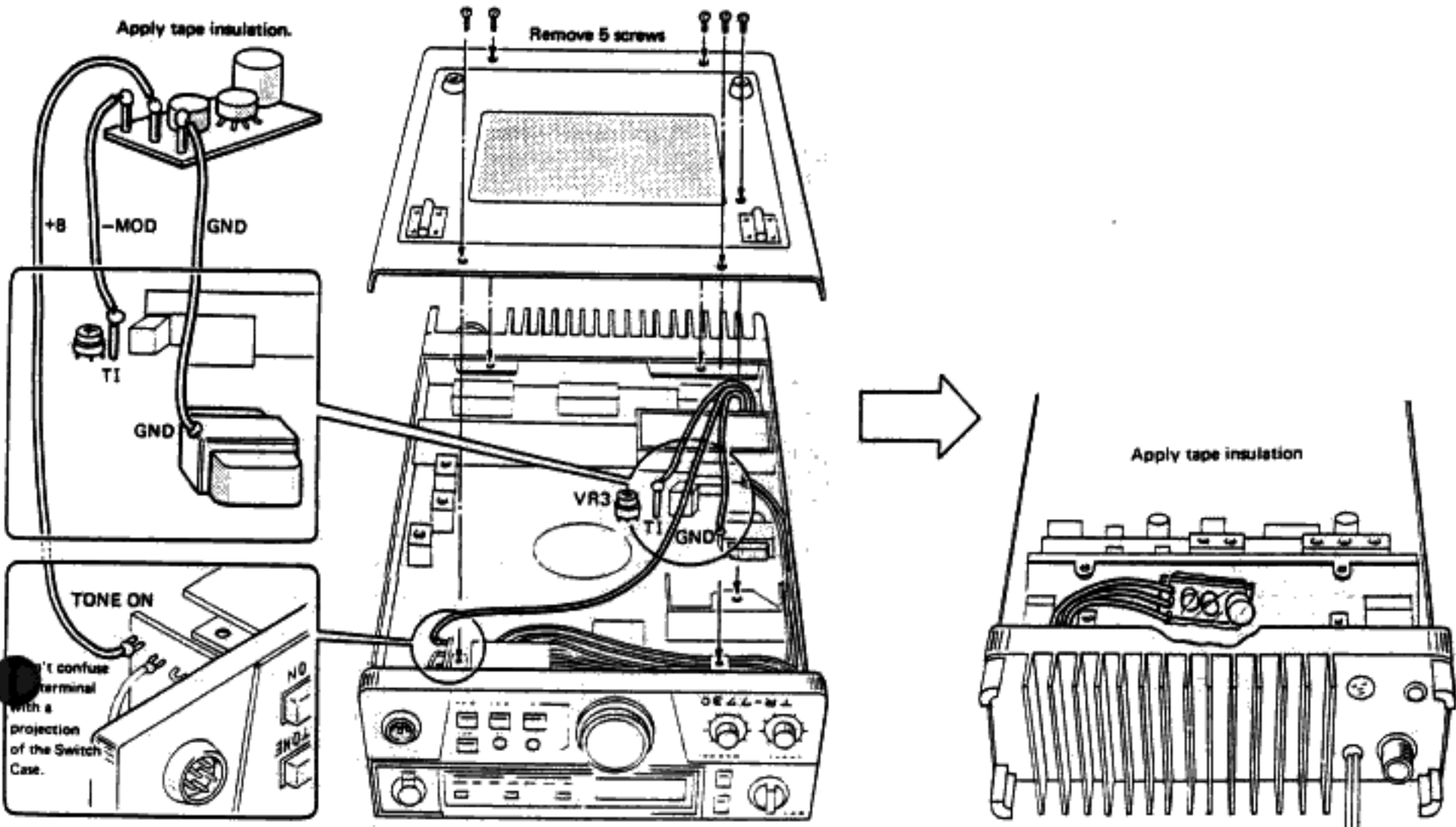

Fig. 3-3

## 3.11 BAIL AND FOOT INSTALLATION

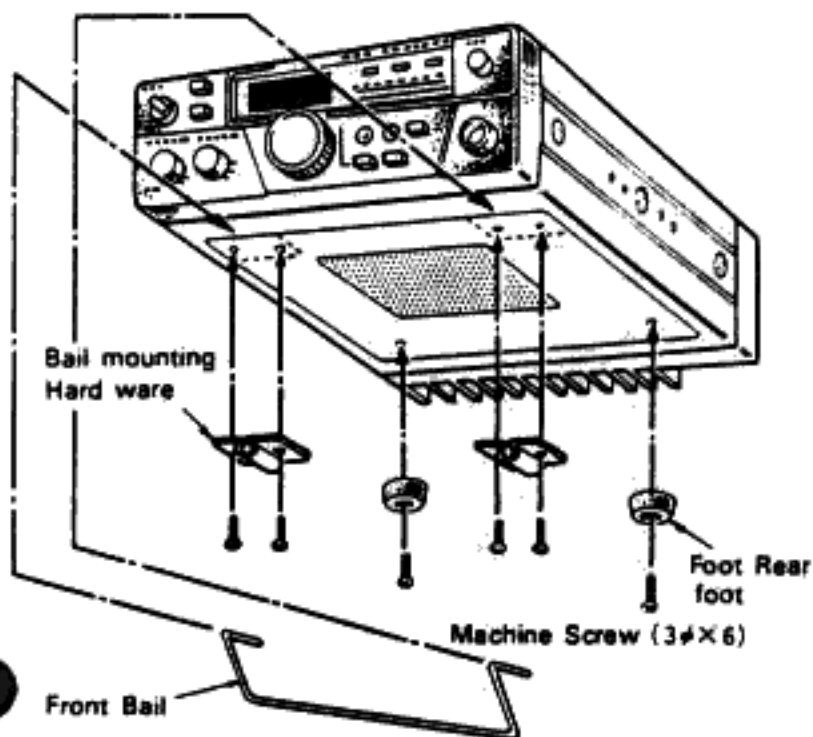

Fig. 3-4

## 3.12 ADJUSTMENTS

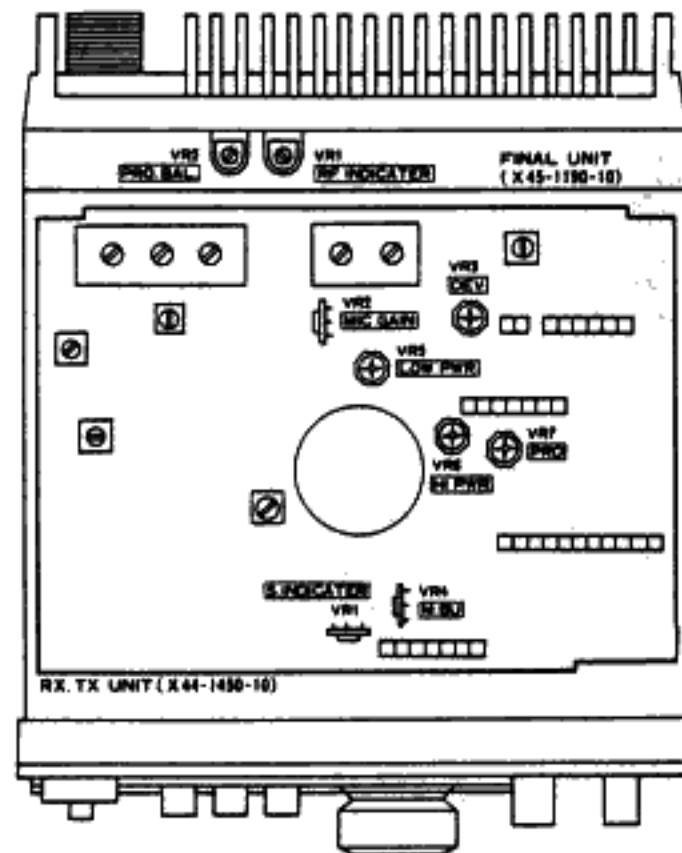

Fig. 3-5

## SECTION 4. ADDITIONAL INFORMATION

### 4.1 GENERAL INFORMATION

Your TR-7730 has been factory aligned and tested to specification before shipment. Under normal circumstances, the transceiver will operate in accordance with these operating instructions.

If your transceiver fails to work, contact the authorized dealer from which you purchased it for quick, reliable repair. All adjustable trimmers and coils in your transceiver were preset at the factory and should only be readjusted by a qualified technician with proper test equipment.

Attempting service or alignment without factory authorization can void the transceiver's warranty.

### 4.2 BATTERY PRECAUTION:

When charging your vehicle battery, or when jump-starting a dead battery, ALWAYS disconnect the power lead from the back of the transceiver.

### 4.3 ORDERING SPARE PARTS

When ordering replacement or spare parts for your equipment, be sure to specify the following:

- Model and serial number of your transceiver. Schematic number of the part. Printed circuit board number on which the part is located. Part number and name, if known, and quantity desired.

**NOTE:**

A full service manual is available as a separate publication.

## SECTION 5. OPTIONAL ACCESSORIES

The following accessories are available for more sophisticated operation of the TR-7730.

### 5-1 Fixed Station DC Power Supply KPS-7

The KPS-7 DC power supply perfectly matches the TR-7730's design. It incorporates a circuit for protecting the transceiver against shorted output and overload.

### 5-2 Autopatch Microphone MC-46

For autopatch operation, the autopatch microphone MC-46 with UP/DOWN switches is recommended.



### 5-3 External Speaker SP-40

Designed for mobile operation. Styling and tone quality match the TR-7730 perfectly.



### 5-4 External Speaker SP-120

Designed for fixed station operation. Styling and tone quality match the TR-7730 perfectly.

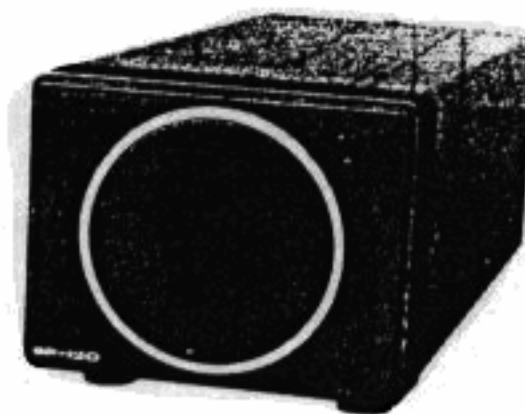

### 5-5 Charger TK-1

This charger is used as a Back-up power supply when the main power supply is off for extended periods.

Model TR-7730

Serial No. \_\_\_\_\_

Date of Purchase \_\_\_\_\_/\_\_\_\_\_/\_\_\_\_\_

Dealer \_\_\_\_\_  
\_\_\_\_\_  
\_\_\_\_\_  
\_\_\_\_\_  
\_\_\_\_\_

---

A product of  
**TRIO-KENWOOD CORPORATION**  
17-5, 2-chome, Shibuya, Shibuya-ku, Tokyo 150, Japan

---

**TRIO-KENWOOD COMMUNICATIONS, INC.**  
1111, West Walnut Street, Compton, California, 90220, U.S.A.  
**TRIO-KENWOOD COMMUNICATIONS, GmbH**  
D-6374 Steinbach TS, Industriestrasse 8A, West Germany  
**TRIO-KENWOOD(AUSTRALIA)PTY. LTD.**  
30 Whiting Street, Artarmon, Sydney N.S.W. Australia 2064

# BLOCK DIAGRAM

