

6K.D6

# **INSTRUCTION MANUAL**

FL-2500

**YAESU MUSEN CO., LTD.**

TOKYO JAPAN

\*\*\*\*\*  
FL-2500 LINEAR AMPLIFIER  
\*\*\*\*\*

GENERAL

The FL-2500 Linear Amplifier is designed to match the "F" series transceivers and transmitters in appearance and drive requirements to run high power input covering the ham bands 160 through 10 meters.

The FL-2500 uses five 6KD6 tubes in a class AB grounded grid circuit configuration. The tubes are forced-air cooled by two very quiet high speed internal fans.

Automatic Level Control circuit controls the exciter gain to allow the highest average power without distortion caused by peak clipping. Changeover circuit biases the tubes to cut-off, eliminating unwanted heat and diode noise generation when receiving.

An internal changeover relay feeds the antenna to the exciter for barefoot operation when the FL-2500 is turned off or is on standby condition. A built-in SWR bridge measures the SWR on by barefoot and linear operations.

The built-in solid state power supply requires no warm-up period and provides excellent voltage regulation.

SPECIFICATIONS

Circuit	: Grounded Grid Class AB
Frequency Coverage	: Ham bands 160 through 10 meters
Plate Input	: 2000 Watts PEP 1500 Watts CW 300 Watts AM
Plate Voltage	: 1250 Volts DC in SSB Mode 900 Volts DC in TUNE/CW Mode
Drive Requirement	: 100 Watts PEP or less
Input Impedance	: 50 ohms, unbalanced
Output Impedance	: 50 ohms, unbalanced
Third Order Distortion	: 30 db or better at 1000 Watts PEP

Tube Complement : 5 x 6KD6  
Cooling : Forced-Air Cooling  
Power Requirement : AC 100, 110, 117 Volts 50/60 Hz 18 Amps  
AC 200, 220, 234 Volts 50/60 Hz 9 Amps  
Dimensions : 14 1/2" Wide, 6 1/4" High, 11 1/2" Deep  
Weight : 44 lbs.

### FRONT PANEL CONTROLS

POWER - OFF : Rocker switch turns power on.  
OPER - STBY : Rocker switch applies Bias when standby and relay is disengaged.  
SWR - IP : Rocker switch selects either SWR or plate current meter reading.  
F - R : Rocker switch selects either forward or reflected SWR bridge reading.  
SENS : Potentiometer adjusts meter sensitivity for SWR measurement.  
PLATE : Plate capacitor in tank circuit.  
MODE (SSB-TUNE/CW) : Rocker switch selects either SSB or TUNE/CW mode.

### INSTALLATION

Carefully remove the FL-2500 from its packing carton and examine it for any visible shipping damage, check the control knobs and switches for complete freedom of action. Should any damage be apparent, notify the delivering carrier immediately stating the nature of the damage in detail.

In general, care should be taken to insure that enough space is allowed around the amplifier cabinet to permit adequate air circulation within the linear amplifier. Do not cover the top of the FL-2500 with books, papers or other equipments. Do not insert anything under the bottom of the FL-2500, or over-heating may result.

## POWER REQUIREMENT

The FL-2500 has a built-in power supply which can be operated from either 100, 117 or 220 volts AC 50/60 Hz. The FL-2500 is shipped from the factory connected to operate on 220 volts AC.

It is recommended that the FL-2500 is operated from its own 220 volts 10 amps or greater circuit. If 117 or 100 volts is all that is available, it should be fused for 30 amps, circuit conductors should be larger than #10 and no other equipment should be operated from this circuit. **DO NOT**, under any circumstances, operate the FL-2500 from a 115 volts lighting circuit, as the circuit conductors are not large enough to carry this load.

The following diagram shows the wiring connections for 110, 117 and 220 volts operation. Connections must be made as shown, or serious damage may result.

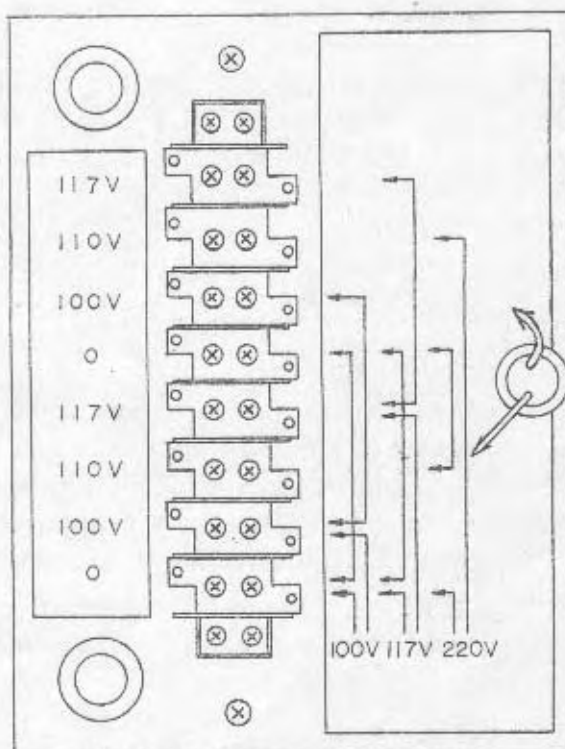

## ANTENNA REQUIREMENT

The FL-2500 has been designed for use with an antenna resonant at the operating frequency and having approximate impedance within the limit of 40 to 60 ohms. The nominal output impedance of the FL-2500 is 50 ohms. When the impedance of the antenna used is far from this value, it is recommended that an antenna matching network be used which will allow the FL-2500 to work into its nominal 50 ohms load for maximum power transfer into the antenna.

## GROUND REQUIREMENT

The FL-2500 should be connected to a good earth ground through as short and as large a gauge wire as possible for best performance and maximum safety. A connecting post marked "GND" is provided on the rear apron of the chassis.

## CAUTION

NEVER OPERATE THE FL-2500 WITHOUT FIRST CONNECTING IT TO AN EARTH GROUND, AND AN ANTENNA OR 50 OHM DUMMY LOAD, OR SERIOUS DAMAGE MAY RESULT

## EXCITER REQUIREMENT

To operate the FL-2500 at its maximum power input, it will be required that the exciter delivers 100 watts PEP SSB output. All our FTdx-500 SOKA-747, FT-250, FT-277 transceivers and FLdx-500 transmitter have sufficient power to drive the FL-2500 at its maximum input. The exciter should be placed as close to the amplifier as practical to avoid long coax and ground connections.

## ALC

On the rear of the FL-2500, a terminal is provided for connection to the exciter of the ALC voltage which controls the gain of the exciter to prevent distortion caused by peak clipping.

### Relay Control

RY and E terminal on the rear of the FL-2500 are provided for connection to the exciter relay circuit which is normally open, and which closes on transmit and thus keys the FL-2500 at the same time. E terminal should be connected to ground for exciters whose relay contact connects to ground on transmit. The terminals are jumpered with a wire for testing purpose when the unit is shipped from the factory.

### OPERATION

#### CAUTION

BE SURE THAT THE FL-2500 IS CONNECTED TO A 50 OHMS ANTENNA SYSTEM OR A 50 OHMS DUMMY LOAD AND THAT THE PROPER POWER CONNECTIONS HAS BEEN MADE FOR THE LINE VOLTAGE THAT IS TO BE USED. (SEE PAGE 3)

For all modes of operation, the FL-2500 is tuned up with a single R. F. frequency driving it. The exciter may be tuned up on CW into the antenna connected to the FL-2500 with operation switch at STBY position, or by leaving the FL-2500 power off. After the exciter has been tuned up, turn the exciter to standby and turn the operation switch to "OPER" position.

### CW and AM Operation

Preset the controls and switches as follows:

POWER switch	: OFF
OPER switch	: STBY
SWR/IP switch	: IP
BAND switch	: Desired band
PLATE control	: To the number given in the chart 1
LOAD control	: Fully counter-clockwise on number zero
MODE switch	: TUNE/CW

Turn the power switch of the FL-2500 on and wait for a few seconds for tubes warm up. Turn OPER switch onto "OPER" position.

Turn on the exciter and increase the exciter output while not exceeding 0.6 amps plate current and tune the plate control for dip in the plate current. Alternately adjust the plate and loading controls while increasing the exciter power in small increments until maximum R. F. output occurs at 1.5 amps plate current. Do not exceed 10 seconds at maximum input to protect the tubes.

Now you are ready for CW and AM operation.

To measure relative power output, set the meter switch to "SWR" and "F" (forward) position. If the relative output meter goes off scale during tune up, reduce the meter sensitivity control in a downward direction. Approximate settings of the loading control at maximum input in TUNE/CW mode are given in the table 1 for 50 ohms load.

For AM operation, tune up the FL-2500 as described previously. Then the exciter should be adjusted to run the FL-2500 at 0.35 amps plate current with unmodulated carrier.

<u>BAND</u>	<u>FREQ. (MHz)</u>	<u>PLATE</u>	<u>LOADING</u>
160	1.8	0.5	10
	2.0	10	10
80	3.5	2	1
	4.0	7	10
40	7.0	4	1
	7.3	5	2
20	14.0	5.5	4
	14.35	6	4.5
15	21.0	8	4
	21.45	8.5	4
10	28.0	8.5	4.5
	29.7	10	5

(Table 1)

### SSB Operation

Pretune the FL-2500 as described in TUNE/CW mode, then turn MODE switch onto SSB position and retune the FL-2500 until maximum R.F. output occurs at 1.5 amps plate current. Do not exceed 5 seconds at maximum input. Approximate settings of the plate control and loading control at maximum input in SSB mode are given in the table 2 for 50 ohms load.

Now you are ready to operate in SSB. The exciter should be adjusted to run the FL-2500 plate current between 0.6 and 0.7 amps under normal voice operating conditions, because the meter cannot follow speech speed.

To measure the SWR of the antenna system, set the meter switch to SWR and apply R.F. power to the antenna. Adjust the meter sensitivity control to read full scale at SWR switch "F" position. Turn SWR switch to "R" position, then SWR may be read directly from upper scale of the meter.

<u>BAND</u>	<u>FREQ. (MHz)</u>	<u>PLATE</u>	<u>LOADING</u>
160	1.8	1	2
	2.0	10	10
80	3.5	1.5	2
	4.0	7	10
40	7.0	4	2.5
	7.3	5	3
20	14.0	5	4
	14.35	6	4.5
15	21.0	8.5	4
	21.45	9	4
10	28.0	9	4.5
	29.7	10	5

(Table 2)



## THEORY OF OPERATION

The FL-2500 is designed to use five 6KD6 tubes in a class AB grounded grid configuration.

The RF driving power delivered to the input is applied to the tube cathodes through a changeover relay and a pi-network.

The RF voltage is coupled through C202 to ALC rectifier diodes D201 and D202. The cathode potential of D201 is determined by VR201 and R202, so that adequate automatic level control voltage is available to control the exciter. The bias is set by R204 for 0.1 amps idle current. In standby, the cold end of S202A is opened so that bias voltage cuts off the tubes. The plate circuit is coupled to the 50 ohms output load by an adjustable pi-network through the SWR bridge circuit.

## SERVICING

### W A R N I N G

EXTREME CAUTION SHOULD BE TAKEN WHENEVER MAKING ANY ADJUSTMENTS INSIDE THE CABINET. BEFORE OPENING THE CABINET COVER, UNPLUG THE POWER PLUG FROM THE AC LINE.

#### Removing Top and Bottom Covers

After disconnecting the power cord from the AC line, the top cover can be easily and safely removed by pulling up the two lock fastners.

The bottom cover can be removed by taking out the four screws on it.

#### Removing Shield Cover

After removing the top cover, the shield cover of the PA compartment can be removed by taking out two screws on the shield cover.

#### Removing the Cabinet

After removing six screws on the front end and two in the bottom of the cabinet, the cabinet can be slid out backwards from the chassis and panel assembly.

#### Tube Replacement

If it becomes necessary to replace the tubes in the FL-2500, the same manufacturer brand should be used.

#### Trouble Shooting

During long periods of operation, it is quite possible that some problem will arise which cannot be cured by tube substitution. If this occurs, it is recommended that you either return it to your dealer or write us in detail.

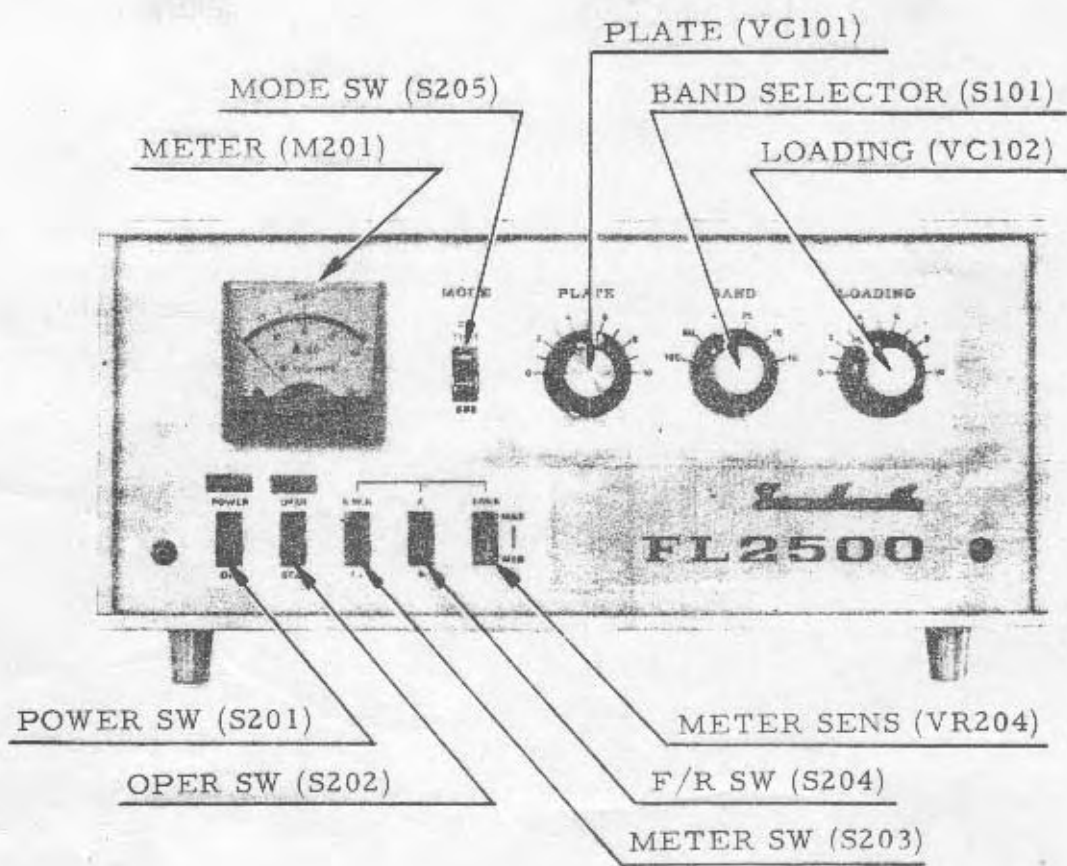

FRONT VIEW

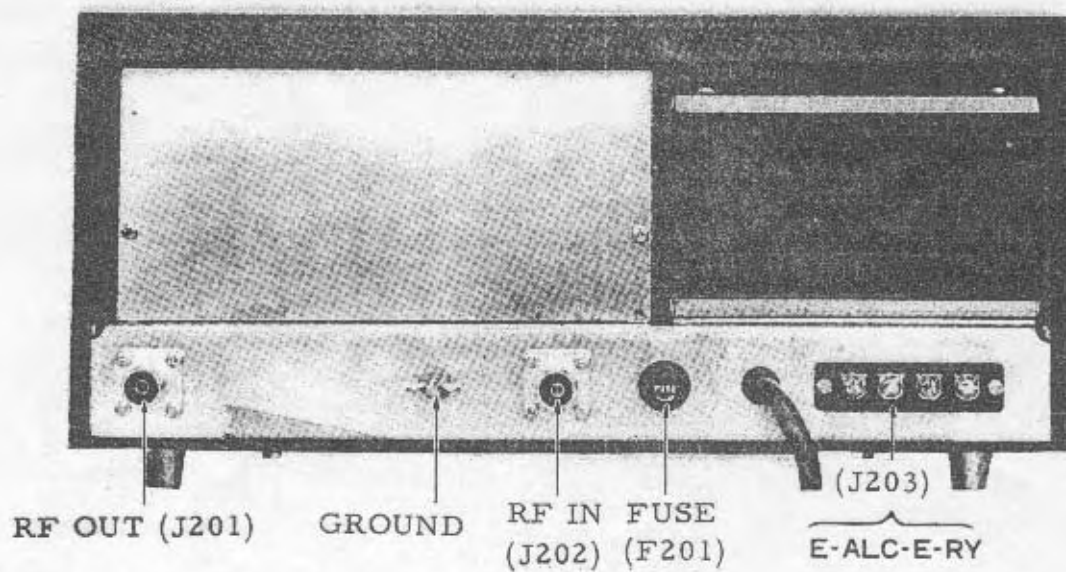

REAR VIEW

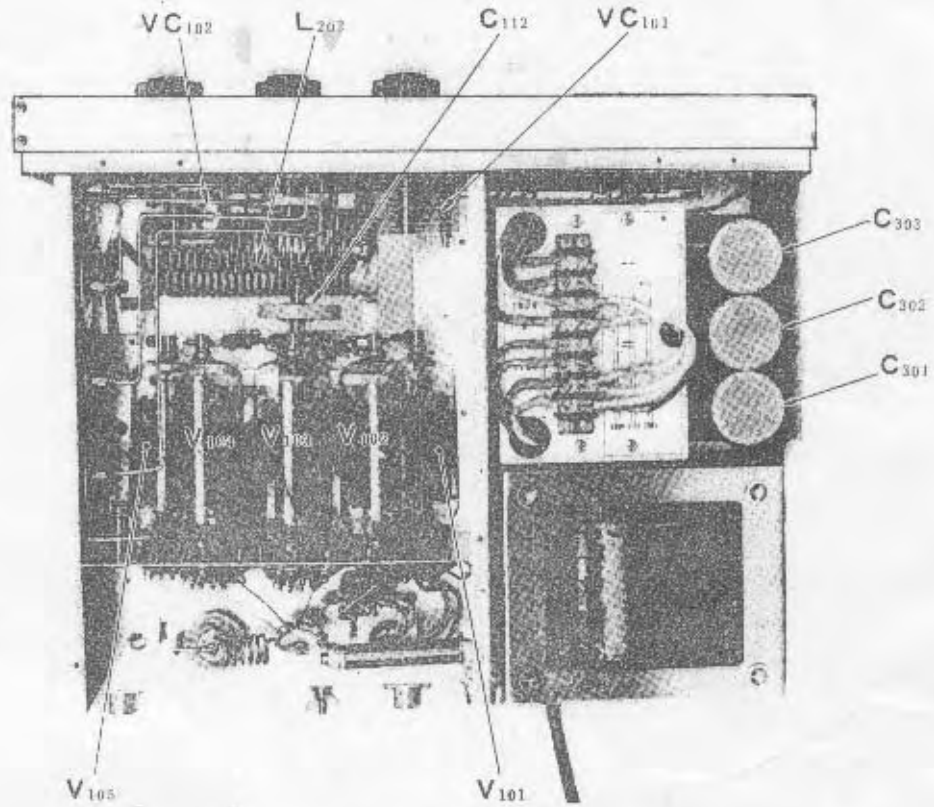

TOP VIEW

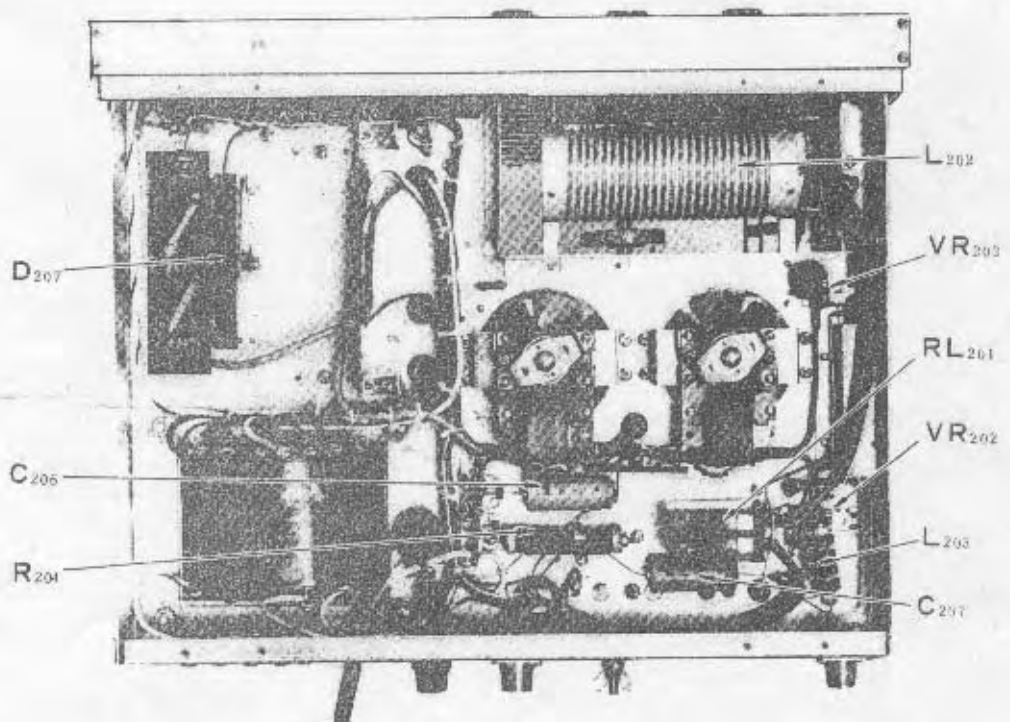

BOTTOM VIEW

# INTERCONNECTION DIAGRAM

FTdx-400/200/560 Transceiver

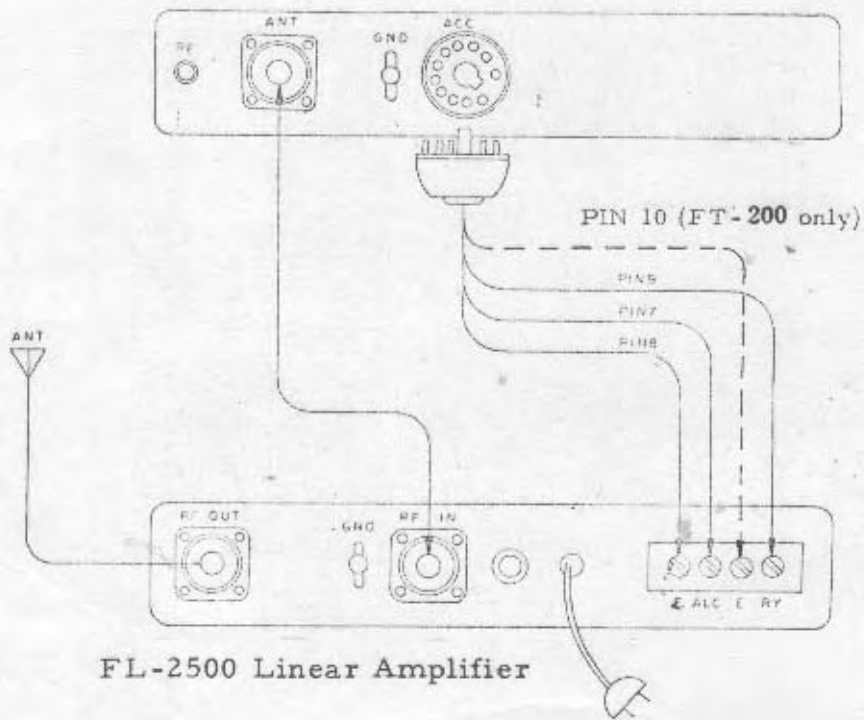

FL-2500 Linear Amplifier

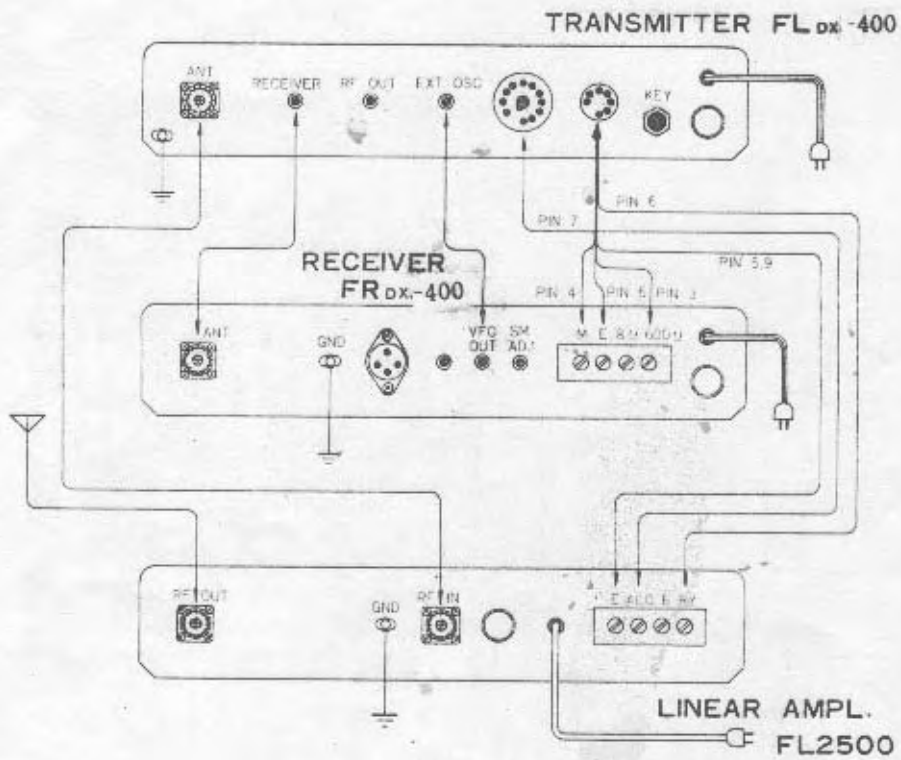

## FL2500 PARTS LIST

<b>V-VACUUM TUBE</b>		<b>VC-VARIABLE CAPACITOR</b>	
101-105	6KD6	101 (PLATE)	YA-270P
<b>D-DIODE</b>		102 (LOADING)	ECV2HA43A44
207	1S269	<b>L-INDUCTOR</b>	
201, 208, 209	1S1007	101	CATHODE CHOKE COIL
202-206	1S1943	102-106	PARASTIC SUPPRESSOR
301-308	10D10	107	PLATE CHOKE COIL
<b>R-RESISTOR</b>		201	LPF COIL
201	½W 47KΩ ±10%	202	TANK COIL
304-311	½W 470KΩ ±10%	203	CHOKE COIL 300μH
101-105	1W 56 Ω ±10%	<b>S-SWITCH</b>	
203	1W 1KΩ ±10%	101	BAND SELECTOR 2-2-6
202	1W 3.3KΩ ±10%	203, 204, 205	WD2101
301, 302, 303	2W 270KΩ ±10%	201, 202	WD2301
312	METER SHUNT	<b>RL-RELAY</b>	
VARIABLE (BIAS SET)		201	AW5221GK
203	10W 100Ω	<b>PB-PRINTED CIRCUIT BOARD</b>	
<b>VR-VARIABLE RESISTOR</b>		PB-1070	
201	EVLS3AA00B14 10KΩ	PB-1091 or PB-1112	
202, 203	EVLS3AA00B52 500 Ω	<b>VS-VACUUM TUBE SOCKET</b>	
204 (SENS)	EVHB0AS15B15 100KΩ	101-105	S-B0703
<b>C-CAPACITOR</b>		<b>MOTOR WITH COOLING FAN</b>	
CERAMIC DISC		2S10A	
101-110, 204, 205, 208-211	500WV 0.01μF $\begin{matrix} +100\% \\ 0 \end{matrix}$	<b>PL-PILOT LAMP</b>	
212, 213	1.4KVDC 0.01μF $\begin{matrix} +100\% \\ 0 \end{matrix}$	201, 202	S-9 8V 0.15A
DIPPED MICA		<b>J-JACK(RECEPTACLE &amp; TERMINAL BOARD)</b>	
202	500WV 10PF ±10%	201, 202 (COAX.)	J50-239
203	500WV 150PF ±10%	203	T-3507 (4P)
ELECTROLYTIC		204	ML-3391 (8P)
301, 302, 303	500WV 100μF $\begin{matrix} 80\% \\ 20 \end{matrix}$	<b>M-METER</b>	
206, 207	50WV 220μF $\begin{matrix} 80\% \\ 20 \end{matrix}$	201	BW-22 1mA
CERAMIC		<b>T-TRANSFORMER</b>	
113	RDA30 3KV 70PF ±10%	201	HI-VOLT. TRANS.
201	RDA30 3KV 100PF ±10%	202	HEATER TRANS.
116, 119	RDA30 3KV 200PF ±10%	<b>F-FUSE</b>	
114, 118	RDA30 3KV 250PF ±10%	AC100-117V 30A	
120	RDA30 3KV 300PF ±10%	AC200-234V 15A	
111	RDA30 3KV 1000PF $\begin{matrix} 100\% \\ 0 \end{matrix}$	<b>FH-FUSE HOLDER</b>	
115, 122-125	RDA40 3KV 500PF ±10%	S-N1001	
112	RDA40 3KV 5000PF $\begin{matrix} 100\% \\ 0 \end{matrix}$		

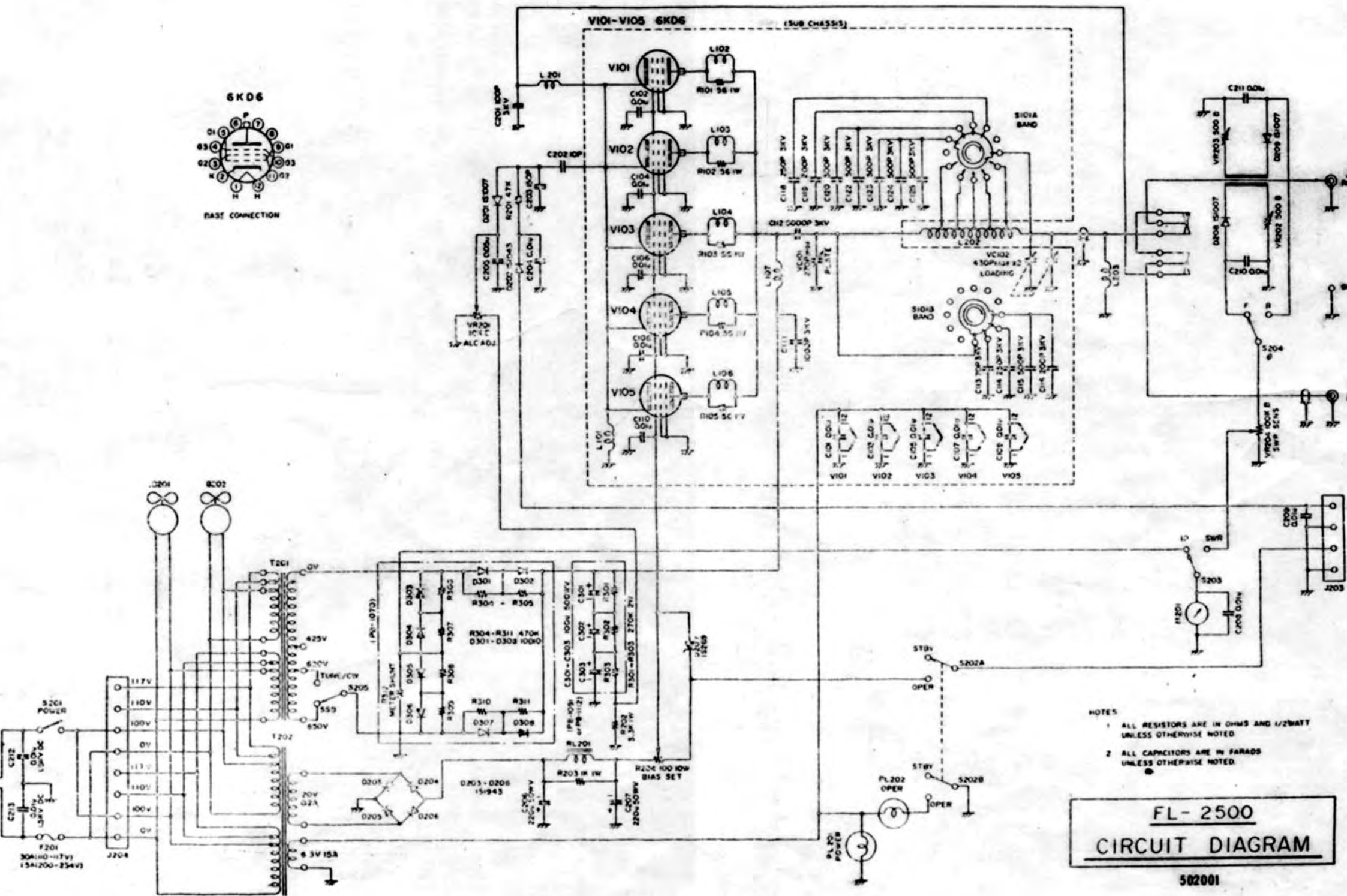
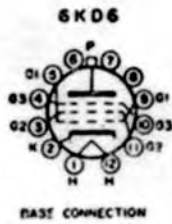

- NOTES
- 1 ALL RESISTORS ARE IN OHMS AND 1/2WATT UNLESS OTHERWISE NOTED.
  - 2 ALL CAPACITORS ARE IN FARADS UNLESS OTHERWISE NOTED.

**FL-2500**  
**CIRCUIT DIAGRAM**





# **K4XL's** **BAMA**

This manual is provided **FREE OF CHARGE** from the "BoatAnchor Manual Archive" as a service to the Boatanchor community.

It was uploaded by someone who wanted to help you repair and maintain your equipment.

If you paid anyone other than BAMA for this manual, you paid someone who is making a profit from the free labor of others without asking their permission.

You may pass on copies of this manual to anyone who needs it. But do it without charge.

Thousands of files are available without charge from BAMA. Visit us at <http://bama.sbc.edu>