

Chinon Auto 6001 / 5501

This manual is for reference and historical purposes, all rights reserved.

This page is copyright © by [M. Butkus, NJ.](#)

This page may not be sold or distributed without the expressed permission of the producer
I have no connection with Chinon Co., Japan

On-line camera manual library

This is the full text and images from the manual. This may take 3 full minutes for all images to appear.

If they do not all appear. Try clicking the browser "refresh" or "reload button" or right click on the image, choose "view image" then go back. It should now appear.

To print, try printing only 3 or 4 pages at a time.

[Back to main on-line manual page](#)

If you find this manual useful, how about a donation of \$3 to: M. Butkus, 29 Lake Ave., High Bridge, NJ 08829-1701 and send your e-mail address so I can thank you.

Most other places would charge you \$7.50 for a electronic copy or \$18.00 for a hard to read Xerox copy.

This will allow me to continue to buy new manuals and pay their shipping costs. It'll make you feel better, won't it? If you use Pay Pal, you can click here to make a donation



TABLE OF CONTENTS

Nomenclature	
Specifications	
SIMPLIFIED FOR BASIC OPERATION	
1. Battery Installation	
2. Automatic Film Speed Setting	
3. Automatic film Loading	
4. Film Cartridge Window	
5. Holding the Camera	
6. Viewfinder Indications	
7. Autofocus Shooting	
A. AUTO 6001	
B. AUTO 5501	
8. Focus Lock System	
9. Zooming System (AUTO 6001 only)	
A. Auto Programmed Zoom Composing	
B. Manual Power Zooming	
10. Manual Power Zooming (AUTO 5501 only)	
11. Flash Photography	
12. Effective Flash Range	
13. Fill-in Flash Photography	
14. Off-flash Photography	
15. Self-timer Photography	
16. Automatic Film Rewinding	
17. Manual Power Film Rewinding	
18. (AUTO DATE)	
19. Care of the Camera	

BASIC CAMERA CARE

- Keep the battery out of the reach of children. If a battery should be swallowed, contact a doctor immediately.
- Batteries should never be subjected to excessive heat, fire, recharging or be intentionally short circuited or disassembled. The battery may be damaged and could result in an explosion.
- Always insert a battery correctly (+/-). Reversing the polarity could cause a chemical reaction or induce an explosion.
- Cameras utilize a high voltage electrical circuit. Never attempt to disassemble the camera. Should service be required, always contact an authorized repair center.
- The Chinon Auto 5501 and Auto 6001 Cameras do not have waterproof bodies. They should not be used in rain or underwater. If the camera should get wet, remove the battery and then wipe the camera dry with a clean cloth. Contact an authorized service center as soon as possible. Do not attempt to disassemble the camera yourself or try to dry the camera in an oven or other heat source.

· Never leave the camera in a closed car situated in direct sunlight. The increased heat build-up can damage the camera

· The neck strap of the camera may cause injury to small children. Always keep the camera safely stored out of the reach of small children.

NOMENCLATURE

1. Manual rewind button
2. Self-timer button
3. Main switch
4. Shutter release button
5. Self-timer indication LED
6. Lens
7. Exposure metering window
8. Viewfinder
9. Flash
10. Flash mode button
11. Auto focus window

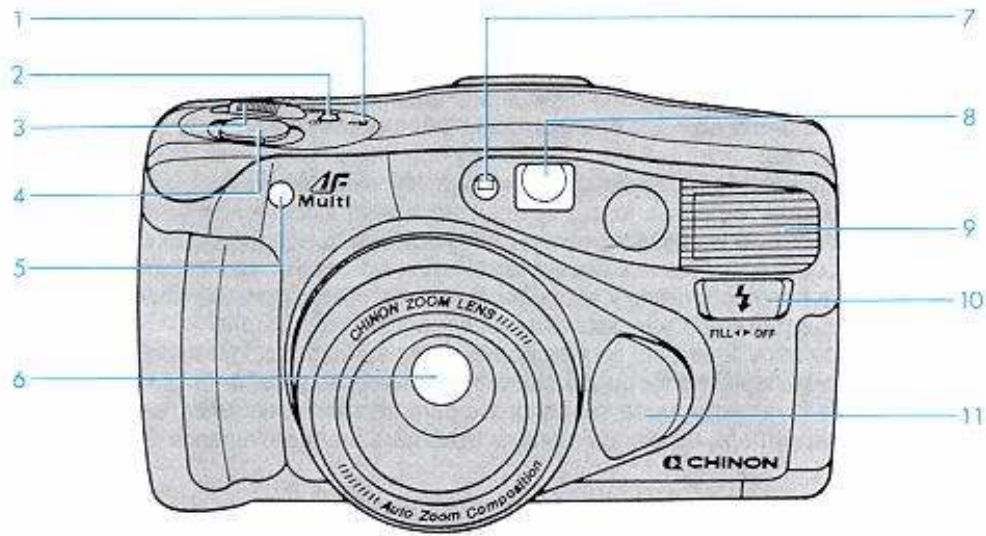

12. Film type window

13. Back cover

14. Take up spool

15. Film type mark

16. Battery compartment cover

17. Viewfinder eyepiece

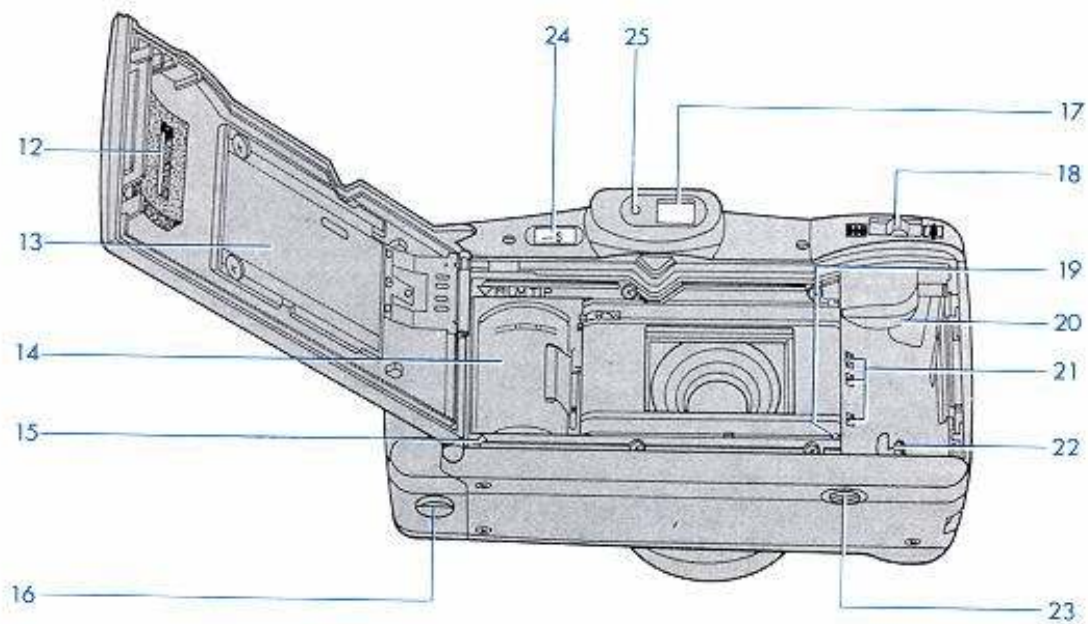

18. Power zoom button (Tale/Wide)

19. Film guide

20. Film chamber

21. Automatic film speed setting contacts

- 22. Film rewind shaft
- 23. Tripod socket
- 24. Frame counter
- 25. OK monitor (Green) LED

AUTO 6001 SPECIFICATIONS

MAIN FEATURES: -35 mm compact zoom camera

- 2 stage Auto program zoom system
- Multi AF system
- Auto DX sensing programmed AE
- Fully motorized film transport
- Built-in sensor flash
- Built-in electronic self-timer
- Long life lithium battery

FILM TYPE: 35 mm film cartridge

PICTURE SIZE: 24x36 mm

LENS: Aperture ratio: F/3.6-7.9

Focal length: f/38 mm-90 mm

Lens construction: 8 elements in 7 groups

Zooming: 2 modes: 2 stage auto program zoom mode: Day light zoom program, Low light zoom program;
Manual power zoom mode

FINDER: Type: Actual imaging zoom finder

Magnification: 0.39-0.86x

Coverage: 82%

Diopter: - 1.0

Finder indications: Auto focus frame, parallax compensation mark, LED Indication: OK monitor (Green LED), light on - "OK indication, blinking - near distance warning, light off - flash charging/low power

FOCUSING SYSTEM: Type: Multi infrared auto focusing system;

AF effective range: W: 1.0 m (39.5") - inf., T: 1.1 m (43.5~) - inf. Prefocus and cancelable

SHUTTER: Type: Stepping motor controlled chargeless shutter

Type of shutter release: Electromagnetic release

Shutter speed range: Approx. 1/4 sec.-1/300 sec.

EXPOSURE DIETER: Type: Programmed AE

Photocell: CdS

Exposure range: Normal program mode: W: EV9.5 - 17, T: EV 11.8 - EV 19.3

Flash program mode: W: EV 6-17, T: EV 8.3 - EV 19.3

Film speed sensing: Automatic for DX films, ISO 100, 200, 400, 1000: ISO 100 for DX films

TRANSPORTATION: Film loading: Auto loading

First frame setting: Automatic setting when the film door is closed

Film winding: Motorized winding

Film rewinding: Motorized rewinding

Rewinding actuation: Automatic

Rewinding stop: Automatic

Rewind button: Yes

Frame counter: ~ Built-in

FLASH: type: Sensor flash

Flashmatic: Yes

Auto recharging: Yes

Flash GN: 14 (ISO 100. meter)

Effective range: Auto program zoom mode: 1.0-6.6 m (39.5' - 21 .6')

Effective range: W: 1.0-6.6 m (39.5"-21.6'), T: 1.1-3.0 m (43.5~-9.84')

Recycle time: Approx. 4 sec.

Fill flash: Yes

Off flash: Yes

Slow synchro: Yes

OTHER FEATURES: Power source: Lithium battery pack (2CR5 x 1): replaceable

Battery check: Yes

Film door window: Built-in

Tripod screw: Built-in: Universal 1/4~'

Self-timer: Built-in: approx. 10 sec.

Auto power shut off: Yes

Strap: Attachable

Lens filter: Built-in sky-light filter

Size: 138 (W) x 77 (H) x 70 (D) (5.4x3.0x2.7)

Weight: 380 g (13.3 ounces)

AUTO 5501 SPECIFICATIONS

MAIN FEATURES: -35 mm compact Zoom camera

- Infrared Auto focusing system
- Auto DX sensing programmed AE
- Fully motorized film transport
- Built-in sensor flash
- Built-in electronic self-timer
- Long life lithium battery

FILM TYPE: 35 mm film cartridge

PICTURE SIZE: 24x36 mm

LENS: Aperture ratio: F/3.6-7.9

Focal length: f/38 mm-90 mm

Lens construction: 8 elements in 7 groups

Zooming: Manual power zoom

FINDER: Type: Actual imaging zoom finder

Magnification: 0.39-0.86x

Coverage: 82%

Diopter: - 1.0

Finder indications: Auto focus frame, parallax compensation mark

LED Indications: OK monitor (Green LED), light on - "OK" indication, blinking - near distance warning, light off - flash charging/low power

FOCUSING SYSTEM: Type: Infrared auto focusing system: 18 steps

AF effective range: W: 1.0 m (39.5)—inf., T: 1.1 m (43.5") inf.

Prefocus and cancelable

SHUTTER: Type: Stepping motor controlled chargeless shutter

Type of shutter release: Electromagnetic release

Shutter speed range: Approx. 1/4 sec. -1/300 sec.

EXPOSURE METER: Type: Programmed AE

Photo cell: CdS

Exposure range: Normal program mode: W: EV9.5 - 17, T: EV 11.8-19.3

Flash program mode: W: EV 6-17, T: EV 8.3-19.3

Film speed sensing: Automatic for DX films, ISO 100, 200, 400, 1000; ISO 100 for non DX films

TRANSPORTATION: Film loading: Auto loading

First frame setting: Automatic setting when the film door is closed

Film winding: Motorized winding

Film rewinding: Motorized rewinding

Rewinding actuation: Automatic

Rewinding stop: Automatic

Rewind button: Yes

Frame counter: Built-in

FLASH: Type: Sensor flash

Flashmatic: Yes

Auto recharging: Yes

Flash GN: 14 (ISO 100. meter)

Effective range: W: 1.0-6.6 m (39.5~-21.6'), T: 1.1-3.0 m (43.5 -9 84)

Recycle time: Approx. 4 seconds

Fill flash: Yes

Off flash: Yes

Slow synchro: Yes

OTHER FEATURES: Power source: Lithium battery pack (2CR5x1): replaceable

Battery check: Yes

Film door window: Built-in

Tripod screw: Built-in: Universal 1/4"

Self-timer: Built-in: approx. 10 seconds

Auto power shut off: Yes

Strap: Attachable

Lens filter: Built-in sky-light filter

Size: 138 (W) x 77 (H) x 70 (D) (5.4 x 3.0 x 2.7)

Weight: 380g (13.3 ounces)

Simplified guide for basic operation

(AUTO 6001 AND AUTO 5501)

1. Install lithium battery (Fig. A).
2. With the AUTO 6001, slide the main switch to the "AUTO" position (Fig. B). With the AUTO 5501, slide the main switch to the "POWER" position.
3. Load the film correctly and close the back door (Fig. C).
4. Be sure the frame counter shows "1" in the frame counter window (Fig. D).
5. Direct the AF mark toward your subject (Fig. E).

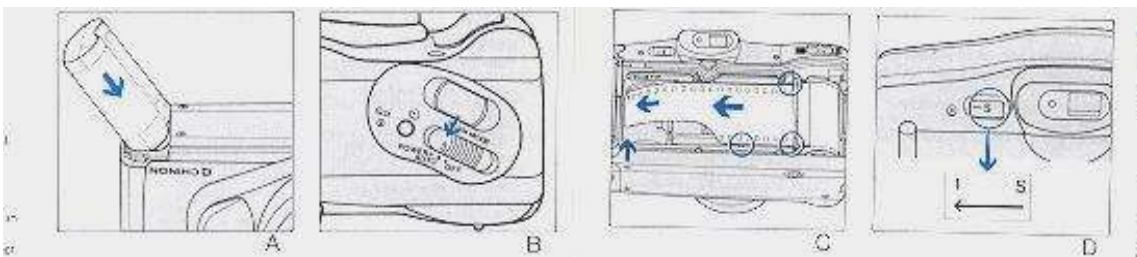

6. Release the shutter by pressing the shutter release button gently (Fig. F).

7. Automatic film rewinding starts at the end of the roll. The frame counter will show "S" upon completion (Fig. G).

8. Remove the exposed film (Fig. H).

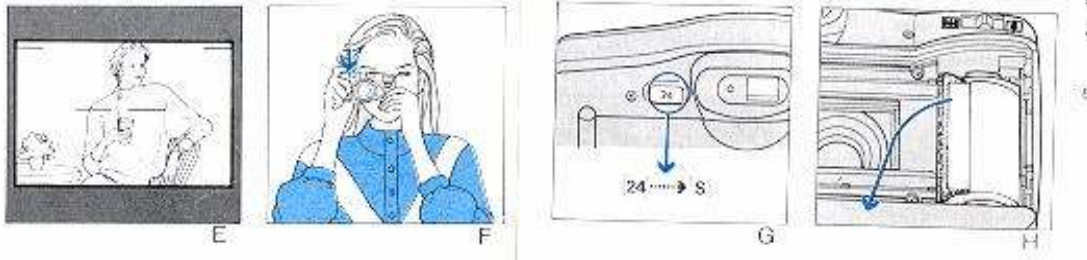

1. Battery installation (AUTO 6001 and AUTO 5501)

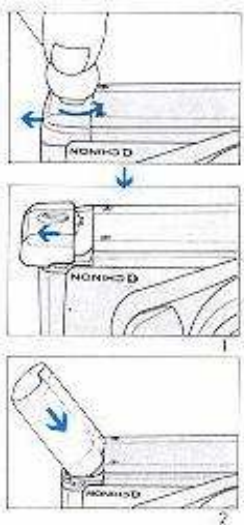

(1) Use a coin and turn it toward the arrow mark to unlock the battery cover. Open the battery cover by sliding it away from the camera (Fig. 1).

(2) Place a 6 volt lithium battery (2CR5) in the battery compartment in accordance with the positive (+) and the negative (-) marks shown inside (Fig. 2).

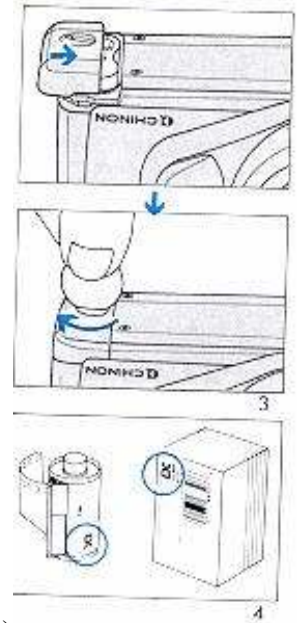

(3) Slide the battery cover back to its closed position and lock the battery cover (Fig. 3)

Note:

When the shutter release is locked or when winding/rewinding becomes extremely slow replace the battery with a new one.

Battery performance declines in cold temperatures. Keep the camera as warm as possible in cold weather.

- The lithium battery will last about three years when used at a frequency of one roll of film of 24 exposures with 50% use of flash on a monthly basis, at room temperature. (Chinon Laboratory Testing)
2. Automatic film speed setting (AUTO 6001 and AUTO 5501)

The film speed is automatically set when using a DX-coded film of ISO 100 to ISO 1000

(Fig. 4). Non DX film will be set to ISO 100. When using reversal film (Slide Film), use films of ISO 100, 200, 400, or 1000.

3. Automatic film loading (AUTO 6001 and AUTO 5501)

Always load and unload your camera in subdued light and never in direct sunlight. This will greatly minimize the possibility of fogging the film.

(1) Open the back cover by sliding the back cover release button downwards (Fig. 5).

(2) Insert the film cartridge into the film chamber (Fig. 6).

(3) Place the trimmed end of the film on the take-up spool up to the film tip mark. Make

sure that the film lies flat between the film guides and that the film perforations engage the sprocket teeth (Fig. 7).

(4) Close the back cover The film will automatically advance to the first frame and the frame counter will show "1 " in the frame counter window.

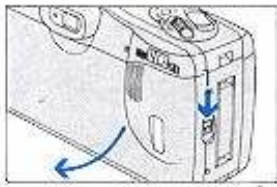

5

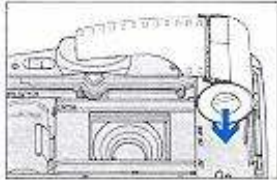

6

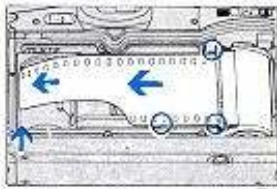

7

Note:

If the frame counter does not show "1" after the film is loaded, open the back cover and reload the film. When placing the trimmed end of the film on the take-up spool, the length of the film pulled out from the film cartridge should not be too long or too short relative to the film tip mark. If too much film is pulled out from the cartridge, adjust the film length by pushing the film back into its cartridge so that the trimmed end of the film will be precisely placed at the film tip mark

4. Film cartridge window (AUTO 6001 and AUTO 5501)

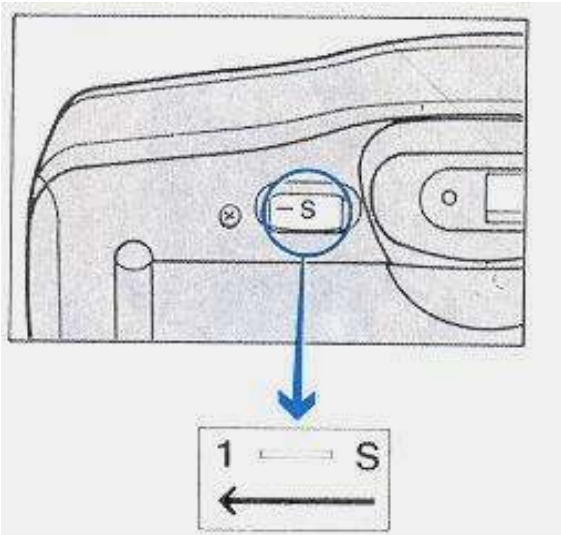

The Chinon AUTO 6001 and AUTO 5501 are equipped with a convenient film cartridge window so that you can confirm what type of film is being used.

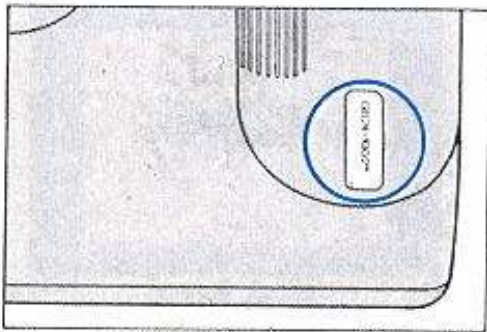

5. Holding the camera (AUTO 6001 and AUTO 5501)

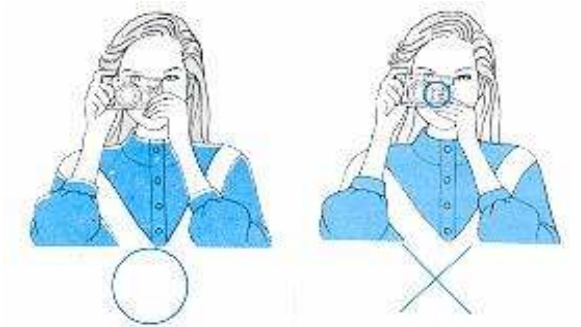

Hold your camera firmly in both hands with at least one elbow at your side to ensure camera steadiness when taking a picture.

Do not cover the lens, flash unit, exposure metering window or auto focus windows with your fingers.

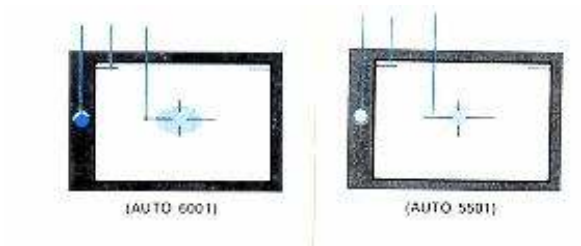

Always press the shutter release button gently to prevent blurred pictures caused by camera shake.

6. View finder (AUTO 6001 and AUTO 5501)

1. AF mark
2. Parallax marks
3. AF indicator LED (Green)

When taking a picture closer than 1.3 meters (3.9 ft), the image area is indicated by the two parallax marks in the top left and right of the viewfinder. Compose the photograph within the imaginary zone extending from the corner of the parallax marks.

7-A. Auto focus shooting (Only for AUTO 6001)

The Chinon AUTO 6001 is equipped with a unique foolproof Multi Auto Focus System where the optimum focus distance is achieved by measuring several different spots within the range of the AF mark.

- (1) Direct the AF mark toward the subject (Fig. 8).
- (2) Gently press the shutter release button halfway. The optimum focusing distance is determined by the subject in the AF mark. The AF indication LED (green) in the viewfinder frame will light up (Fig. 9).
- (3) Fully press the shutter release button to take the photograph.

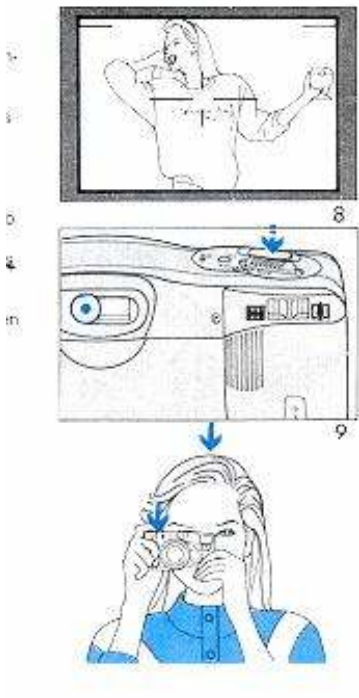

Note:

If the AF indication LED blinks continuously, the subject is too close to the camera to be in focus.

The effective coverage angle of the Multi Auto-Focusing System varies with the lens, focal length (Fig. 10), as per the illustration below. In the telephoto lens setting the actual effective coverage angle is wider than the AF mark. However, at the wide angle setting, effective coverage will be narrower than the AF mark. Therefore, when taking a photograph of a small subject, it is recommended to point the center of the AF mark directly at the subject to obtain the best results.

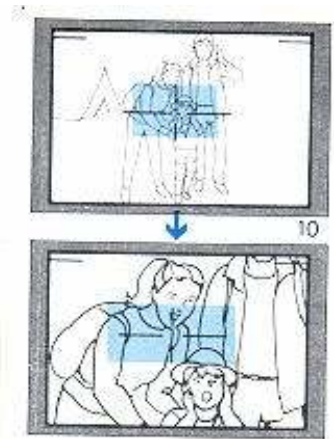
**Note:**

The following subjects will not be properly auto-focused. In these situations we recommend that you focus on another object at approximately the same distance from the camera and use the focus-lock feature described in the next section.

Shiny subjects such as water or the exterior of a car body.

Subject shot through a glass window.

Semi-reflective subjects.

Surfaces that reflect almost no light such as dark hair.

7-B. Auto focus shooting (Only for AUTO 5501)

(1) Direct the center of the AF mark toward the subject (Fig. 11).

(2) Gently press the shutter release button halfway The AF indication LED (Green) in the viewfinder frame will light up (Fig. 12).

(3) Fully press the shutter release button to take the photograph.

· If the AF indication LED blinks, the subject is too close to the camera to be focused properly.

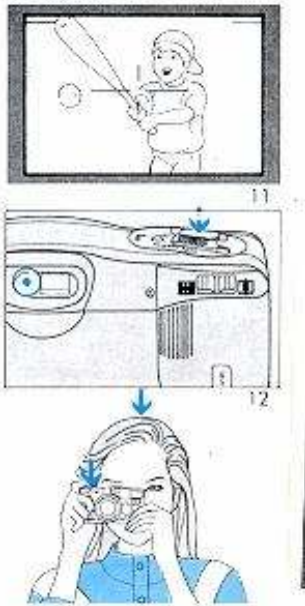

8. Focus lock system (AUTO 6001 and AUTO 5501)

This feature may be used when the main subject is located "OFF CENTER" in the view finder

(1) Focus on the main subject by placing the subject within the auto-focus mark and partially depress the shutter release button until the AF indication LED light up (Fig. 13).

(2) While holding the shutter release button in this position. recompose the subject within the viewfinder and fully depress the shutter release to take the picture (Fig. 14).

(3) The locked focus setting will be held only as long as you partially depress the shutter release button and the AF indication LED remains lighted. This focus lock feature can be cancelled by removing your finger from the release button.

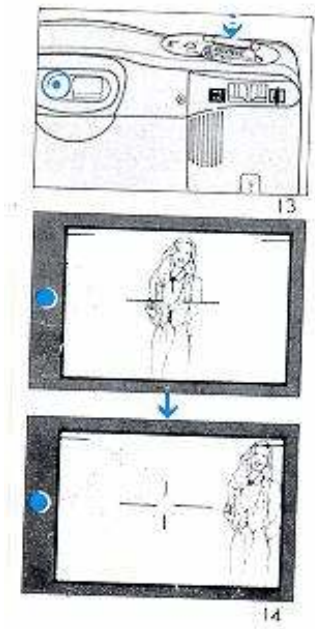

9. Zooming system (Only for AUTO 6001) The Chinon AUTO 6001 is equipped with the world's first 2 stage auto programmed zoom composing system that automatically selects an optimum picture composing angle based upon the dates of the subject distance, its position relative to the camera and scene brightness.

A. Auto programmed zoom composing

(1) Slide the main switch to the "AUTO" (Auto Programmed Zoom) position (Fig. 15).

(2) Point the multi AF mark at the subject (Fig. 16).

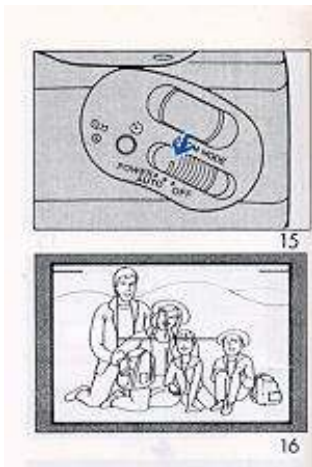

(3) Press the shutter release button halfway and the camera will automatically set the zoom lens to the correct programmed focal length according to the subject composition (Fig. 17).

(4) Press the shutter release button completely to take the photograph.

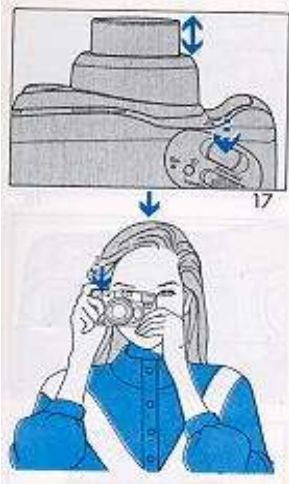

Note:

In day-light situations, the auto programmed zoom composing system is basically designed for portrait picture taking. Therefore, when a picture with a wider perspective, such as scene is desired, use of the manual power zooming mode is recommended.

In low-light situations (when the sensor flash fires), the auto programmed zoom composing system will selects a lens focal length with a wider position than for day light situations. This will help to avoid an under exposed photograph of the main subject.

When the camera is not in use, the main switch should be turned to the "OFF" position in order to protect the lens system from accidental damage.

Never push or twist the lens barrel as this may cause damage to the zoom lens.

The zoom system will not function while the shutter release button is depressed.

B. Manual power zooming

When you prefer to compose the picture yourself, use the manual power zooming system.

(1) Slide the main switch to the "POWER" (Manual Power Zooming) position (Fig. 18)

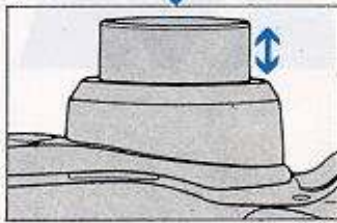
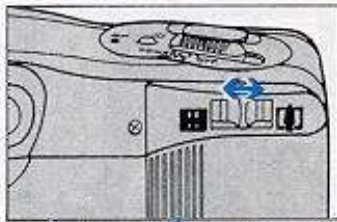
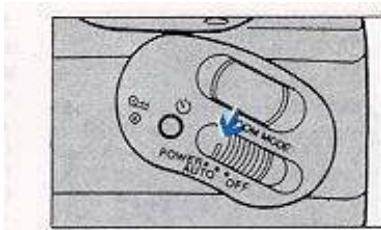

(2) Turning the manual power zoom lever to the right (TELE) or to the left (WIDE) will change the image size

(Fig. 19).

(3) Select the preferred composition by turning the manual power zoom lever while looking at the subject through the viewfinder

(4) Press the shutter release button completely to take the photograph.

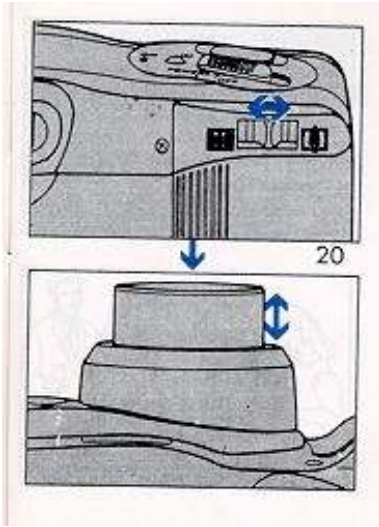

Note:

When the camera is not in use the main switch should be turned to the "OFF" position in order to protect the lens system from accidental damage.

Never push or twist the lens barrel as this may cause damage to the zoom lens.

The zoom system will not function while the shutter release button is depressed.

10. Manual power zooming (AUTO 5501)

The Chinon AUTO 5501 is equipped with a manual power zoom to enable you to select the zoom range to compose the picture.

(1) Turn the manual power zoom lever to the right (TELE) or to the left (WIDE) to change the zoom range (Fig. 20).

(2) Select the preferred composition by turning the manual power zoom lever while looking at the subject through the viewfinder.

(3) Press the shutter release button completely to take the photograph.

Note:

When the camera is not in use, the main switch should be turned to the "OFF" position in order to protect the lens system from accidental damage.

Never push or twist the lens barrel as this may cause damage to the zoom lens.

The zoom system will not function while the shutter release button is depressed.

11. Flash photography (AUTO 6001 and AUTO 5501)

The Chinon AUTO 6001 and AUTO 5501 automatically sense the scene brightness and fire the flash when needed.

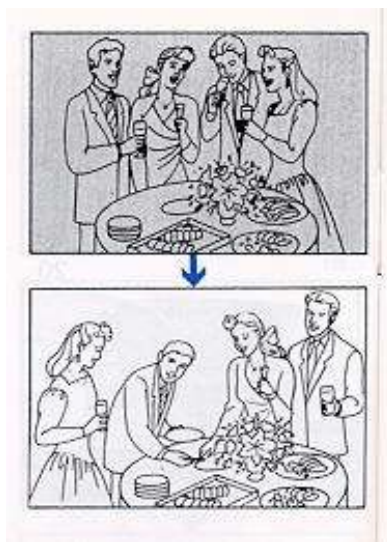

(1) When the shutter release button is pressed halfway and it the AF indication LED blinks once and then disappears, it means the flash is being charged. You must wait until it glows steadily before you take a picture. If it does not blink during the flash charging cycle or does not glow at all, the battery is too weak and battery replacement is required.

(2) The flash will be fully charged in about 4 seconds when using a fresh battery.

Note:

The shutter cannot be released until the flash is completely charged. The flash will be charged even if the shutter release is kept fully depressed. The shutter will be released immediately upon the completion of the flash charging cycle.

- When the main switch is fumed on after a bang period of inactivity, the initial flash recycling time may take longer than the normal flash recycling time.

12. Effective flash range (AUTO 6001 and AUTO 5501)

(Auto programmed Zoom (WIDE))		(TELE)			
ISO 100	1.0 - 6.6 m (3 - 21.6 ft)	ISO 100	1.1 - 3 m (3.6 - 9.8 ft.)		
ISO 200	1.0 - 9.3 m (3 - 30.5 ft)	ISO 200	1.1 - 4.2 m (3.6 - 13.7 ft.)		
ISO 400	1.0 - 42.9 m (3 - 42.9 ft)	ISO 400	1.1 - 6.0 m (3.6 - 19.6 ft.)		
ISO 1000	1.0 - 18.5 m (3 - -)	ISO 1000	1.1 - 8.4 m (3.6 - 27.5 ft.)		

	60.6 ft)				
--	-------------	--	--	--	--

(Webmaster: be reminded that any flash distance is also based on what items reflect the light back to the electric eye. Hence, your subjects 40 feet back will still be underexposed if a number of objects 15 feet from the camera reflect enough light back to turn off the electric eye.)

13. Fill flash mode (AUTO 6001 and AUTO 5501)

It the main subject has less light falling on it than on the surrounding area and back ground, under exposure of the main subject may result. In this case, use of the Fill flash feature is recommended. This feature permits the flash to fire and results in additional light falling on the subject. To use the Fill flash mode, slide and hold the flash selector switch at the "FILL" position. The flash will fire when the shutter is released (Fig. 21). When the fill flash mode is activated, the exposure system automatically compensates for back lighted situations.

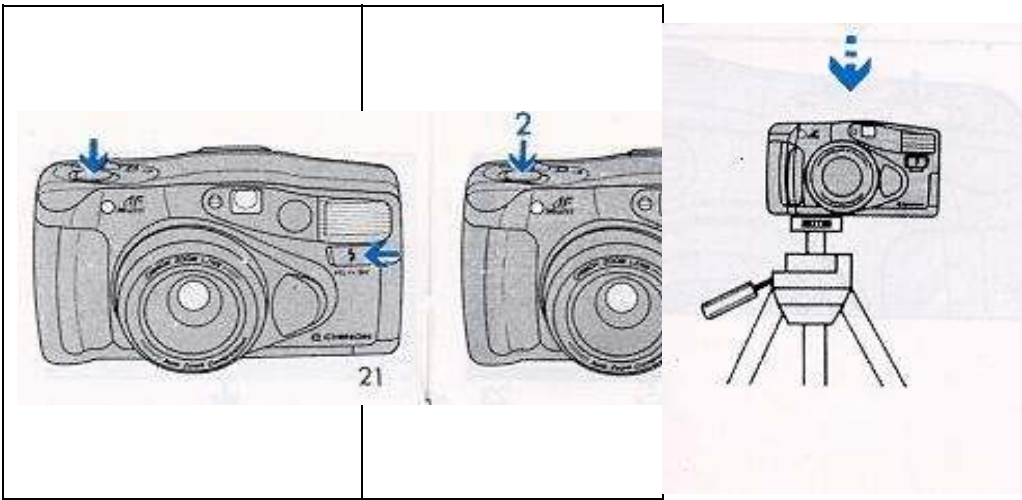

Note:

In the fill flash mode, the slow shutter program AE will be automatically activated.

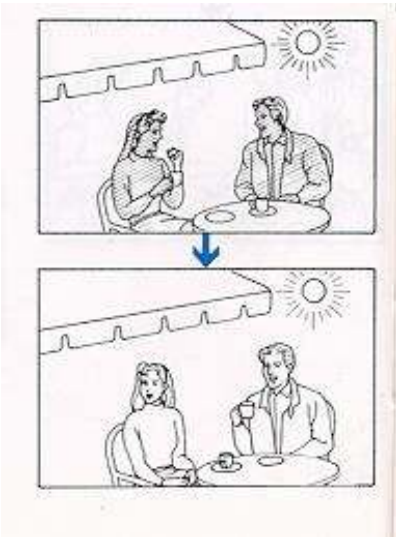

The shutter may be tripped at a timed speed as slow as 1/4 second. This slow shutter speed flash synchronization enables beautiful night scenes to be depicted while having the foreground subject flawlessly exposed by the fill flash. The use of a tripod to avoid camera shake is recommended in low light situations when taking fill flash pictures.

· The auto programmer zoom composing system will automatically select the day-light program mode for portrait picture taking. **14. Off-flash mode (AUTO 6001 and AUTO 5501)**

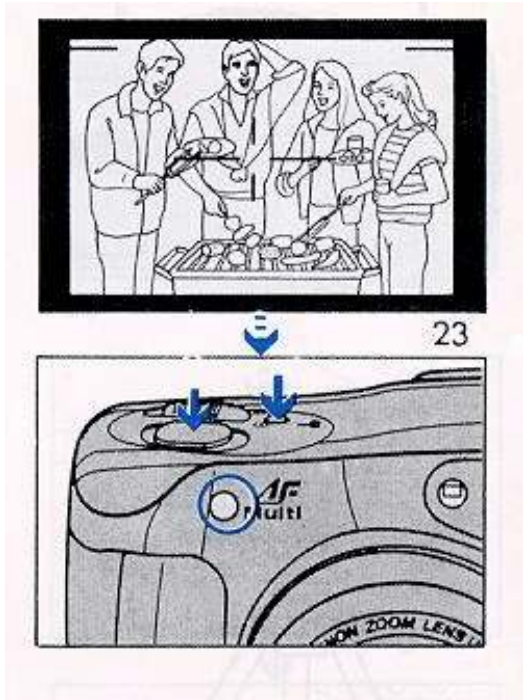

When you do not wish to use the flash at all, especially indoors or for dim lighting situations, the Off-flash mode should be activated.

To use the Off-flash mode, slide and hold the Hash selector switch at the "OFF" position, and release the shutter (Fig. 22).

Note:

· In the Off-flash mode, the slow shutter program AE will be automatically activated. The shutter speed may be as slow as 1/4 sec., depending upon the scene brightness. Therefore, the use of a tripod is recommended for low light situations. The auto programmed zoom composing system will automatically select the Day-light program mode, for portrait picture taking. **15. Self-timer (AUTO 6001 and AUTO 5501)**

The self-timer feature allows the photographer to be in the picture.

(1) Place the camera on a tripod or other film support, and direct the AF mark toward the subject (Fig. 23).

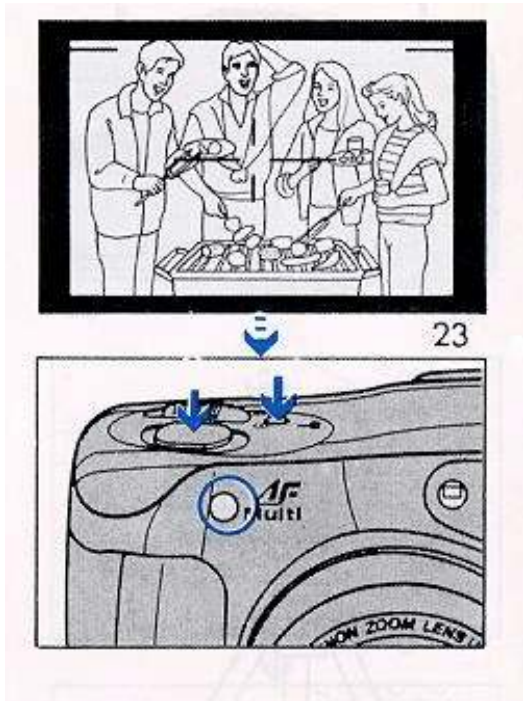

(2) Press and hold the self-timer button on the top of the camera and then press the shutter release button completely to start the self-timer operation.

(3) The self-timer indication LED will light up and the picture will be taken in approximately 10 seconds. The self-timer indication LED will initially glow and then will blink for 2 seconds before the shutter is released. **Note:**

To cancel the self-timer during its "COUNT DOWN", press the self-timer button once or slide the main switch to the "OFF" position.

· When taking a picture of yourself with Auto 6001, it is recommended to compose the picture manually by using the power zoom. Otherwise, the auto programmed zoom composing system will automatically adjust the picture composition without you in the picture taking area and the optimum composing angle may not be selected. **16.**

Automatic film rewind (AUTO 6001 and AUTO 5501)

(1) When the roll of film is completed, a delay of from two to three seconds will occur before the camera automatically starts rewinding the film. During the rewinding, the frame counter will count backwards.

(2) When the rewinding is completed, the motor will stop automatically and the frame counter will reset to the start "S" position (Fig. 24)

(3) Push the back cover release button down to open the back cover and remove the cartridge from the film chamber,. Be sure the frame counter shows "S" before opening the back cover. **17. Manual rewind (AUTO 6001 and AUTO 5501)**

If you want to rewind the film before it has been fully exposed, push the rewind button on the top of the camera. Use a ball-point pen or a similar object which is not too sharp. The camera will then perform as it did under the "FILM REWINDING" section (Fig. 25).

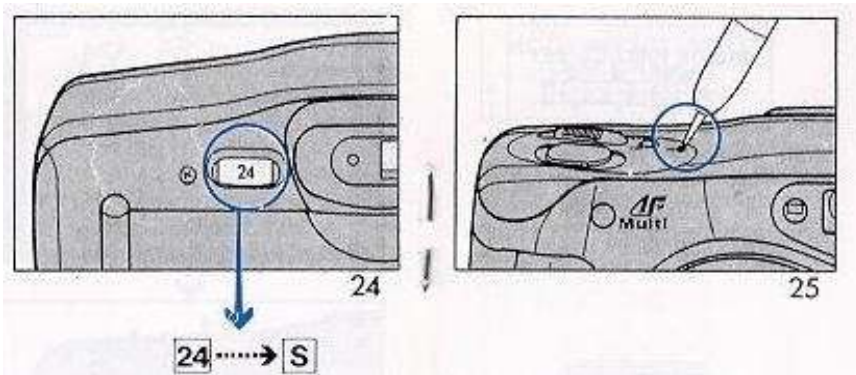

18. (AUTO DATE)

(1) YEAR/MONTH/DAY, DAY/HOUR/MINUTES SETTINGS

(A) Year/month/day setting

Example: 24 December, 1991

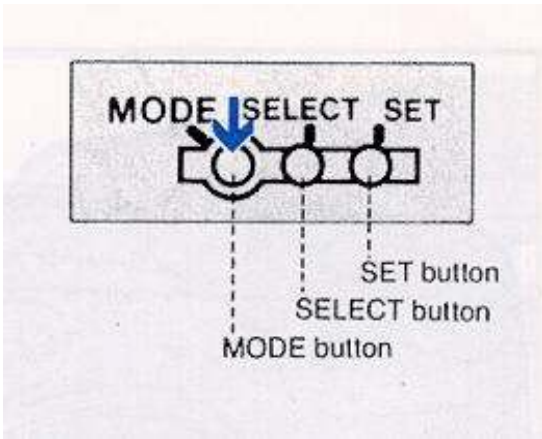

1. With a ball point pen or similar object (fingernail), press the MODE button for the year/month/day setting.
2. With a ball point pen or similar object (fingernail), press the SELECT button to locate the "year" position. A blinking number will appear.

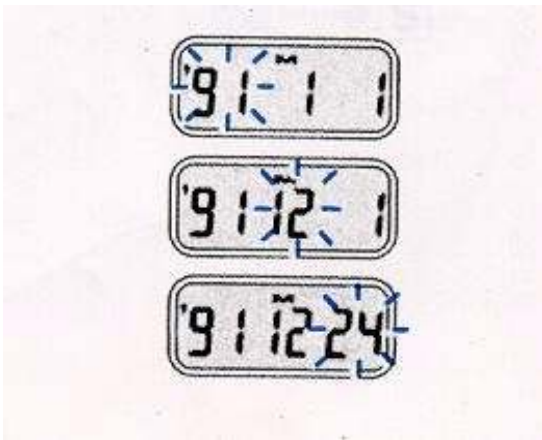

3. With a ball point pen or similar object (fingernail), press the set button to set

4. Press the SELECT button to locate the "month" position above whose number the "M" (month) indication always appears and whose number appears blinking. Then, press the SET button until "12" appears.
5. Press the SELECT button to locate the "day" position. The blinking "day" indicating number will appear. Then, press the SET button until "24" appears. Every time you press the SET button, the number shown on the display window proceeds consecutively. When you press and hold the SET button for more than a second, the numbers will change continuously.

(B) Hour/minute setting

Example: 19:58 (7:58 PM)

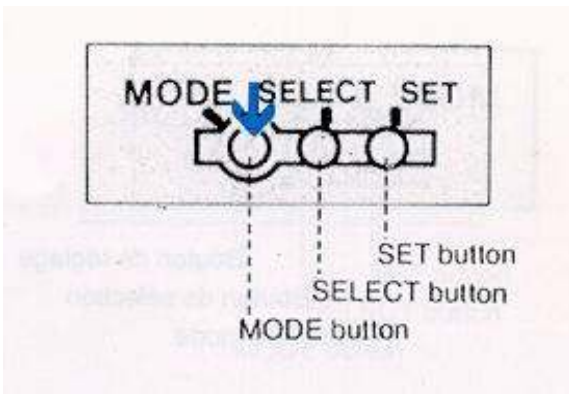

1. With a ball point pen or similar object (fingernail), press the MODE button for day/hour/minute setting.
2. With a ball point pen or similar object (fingernail), press the SELECT button until a blinking "!" appears. Press the SET button to start "00" second.
3. Press the SELECT button to locate the blinking "minutes" position. Press the SET button to set "58".
4. Press the SELECT button to locate the blinking "hour" position. Press the SET button to set "19".



(2) DATA IMPRINTING

When the above procedure (1) is completed, select, by depression of the MODE button the year/month/day, month/day/year, day/month/year mode, day/hour/minute mode or non imprinting mode that is desired.

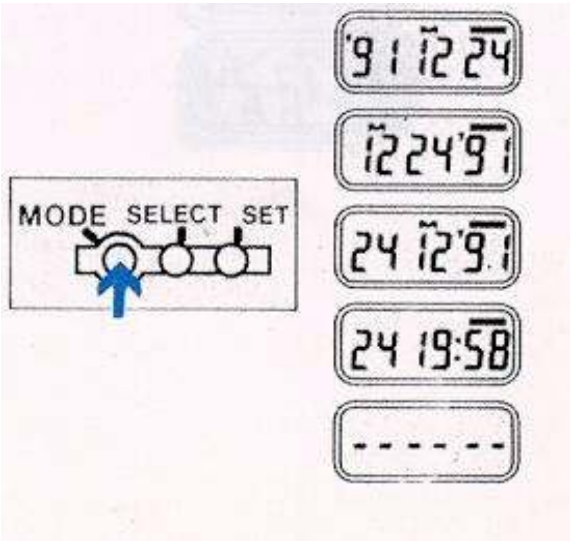

Note:

* The data will not be sharply defined if the picture content on the bottom right hand corner of a horizontal picture is white or yellow.

* Imprint display "-" in the upper right corner of the LCD will blink until the completion of the imprinting.

* Make sure that the "-" appears fit on the LCD before releasing the shutter during imprinting.

* The Auto Date back Is powered by the camera's battery. The following steps should be taken as soon as possible to avoid any loss of data.

1. When replacing the battery, do so as quickly as possible. If the Auto Date back is left without a battery for two to three hours, the time and date readings may be incorrect even after a replacement battery has been installed.

2. If an incorrect LCD indication appears after the installation of a new battery, reinstall the battery in the battery compartment or "reset" it by releasing the shutter.

3. Always check for the correct time and date indications after replacing the battery.

IMPORTANT

1. To clean the unit, use a dry cloth without any cleaning agent

2. Do not depress the buttons with sharp or pointed object such as a knife.

3. Rough handling may result in damage to the unit.

4. Keep the lithium battery out of the reach of children.

LCD Information

1. Use the unit at temperatures between -10°C and +50°C for normal operation of the liquid crystal.

2. Do not expose the unit to the direct rays of the sun for a long time since the LCD may turn black at temperatures above 60°C (140°F).

3. Performance of the LCD declines as the temperature becomes low.

19.Care of the Camera

This camera is a precision photographic instrument. When used with care it will provide years of trouble-free service. Protect your camera from dirt, rain, dampness and excessive heat. Avoid touching the lens. To clean the

lens, wipe it gently with a soft lintless cloth or tissue. Do not use eyeglass tissues as they might damage the lens coating. Do not open and touch the inside of the camera as possible high voltage in the flash circuitry can be dangerous. When the camera will not be in use for a long period of time, turn off the Main Power Switch and store in a well ventilated, cool, dry place. Due to the sensitive characteristics of the micro computer built into the camera, the camera may not operate properly even when a fresh battery is installed. It is not a malfunction. If this should occur, turn the Main Power Switch "ON" and "OFF" or reinstall the battery again.

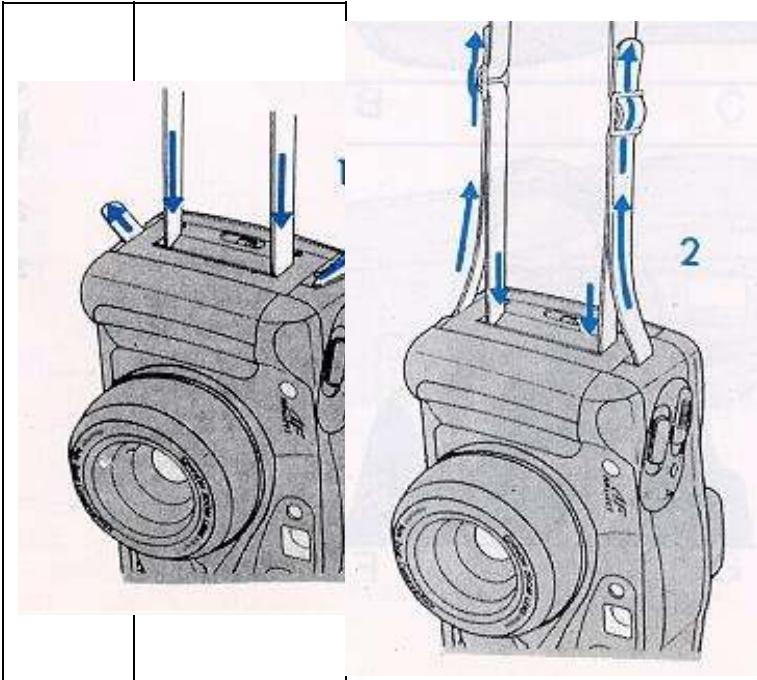

Because we continually strive to improve our products, we may change specifications without prior notice