



WIN W1500 / W500 HANDSET USER GUIDE



©August 2003
WIN® Communications Corporation
6755 Jimmy Carter Blvd.
Norcross Ga. 30071

Chapter 1 KHS3040 Wireless Handset User Guide	1-1
Handset Batteries	1-1
Battery installation	1-1
Charging	1-2
Handset Usage	1-2
Key Functions	1-2
Powering the Handset Off and On	1-3
Placing calls	1-3
Last Number Redial	1-3
Speed Dialing	1-3
Busy Queue	1-4
Answering Calls	1-4
Internal Calls	1-4
External Calls	1-4
Selected Trunk/Line Answer	1-4
Page Answer	1-4
Calls in Progress	1-4
Volume Adjustment	1-4
Microphone mute	1-5
Holding Calls	1-5
Transferring Calls	1-5
Screened Transfer	1-5
Unscreened/Blind Transfer	1-5
Transfer via Paging	1-5
Trunk-To-Trunk (Transfer to Outside Line)	1-5
Conferencing Calls	1-6
Parking Calls	1-6
Call Park	1-6
Group Park	1-6
Direct Group Park	1-7
Call Forwarding	1-7
Direct Forwarding	1-7
Follow-Me Forwarding	1-7
External Forwarding	1-8
Call Pick-Up	1-8
Direct	1-8
Group	1-8
Selected Trunk Hold Answer	1-8
Account Code Registry	1-8
Paging	1-9
Do Not Disturb	1-9
Agent Features	1-10
Log On	1-10
Log Off	1-10
Unavailable	1-10
Wrap-Up	1-10
Available	1-10
Handset Menus	1-11
Menu Structure	1-11
Profiles	1-11
Profile Features	1-12
External Services	1-13
Battery Capacity	1-13
Telephone book	1-13
Alphanumeric Keyboard Functions	1-13
Edit the Phone Book	1-14
Handset Redial Memory	1-14
Menu Subscription and Login	1-14
Create Subscription	1-14
Login	1-15
Auto Login	1-15

Removing Subscriptions 1-15
Text Messages 1-15
Reading Text Messages 1-15
Reply to a Text Message 1-15
Forward a Text Message 1-15
Delete All Text Messages. 1-15
Menu Language 1-15
Menu Shortcuts 1-16
Error Codes 1-16

KHS3040 Wireless Handset User Guide

HANDSET BATTERIES

Battery installation

Before using the handset the battery must be connected to the connector in the battery box. Assemble the back cover as described, and place the handset into the charger.

1. Push the back cover 5mm towards the headset plug using your thumbs.
2. Lift off the back cover.
3. Write down the serial number of the handset. (If the battery is already installed, lift the battery up to view the serial number.)
4. If the battery is not already installed, inset the battery plug in the slot in the battery box.
5. Insert battery with the label facing outwards, and replace the cover.

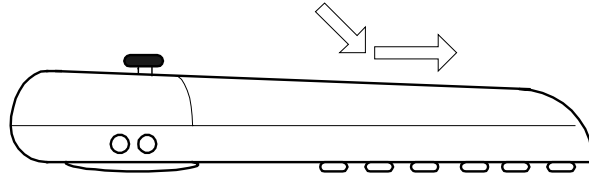

Figure 1 Push the back cover 5mm towards the headset plug using your thumbs.

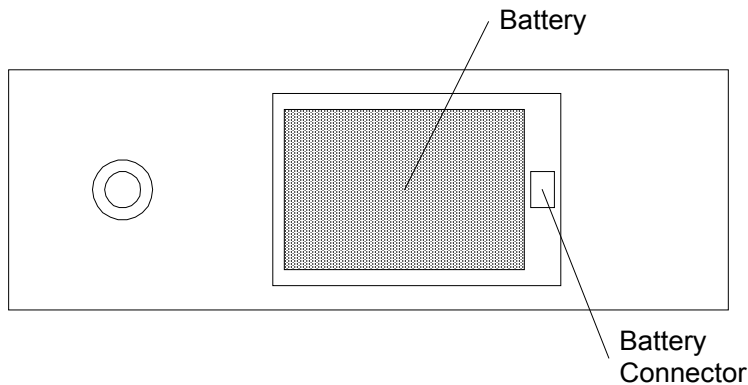

Figure 2 Place the battery plug in the slot.

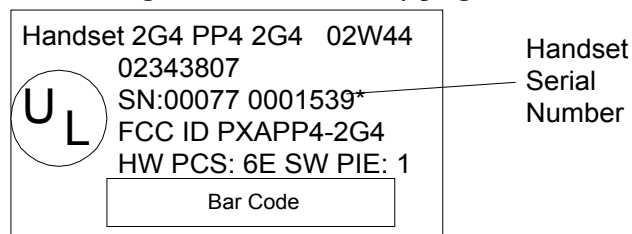

Figure 3 Handset Serial Number

Charging

IMPORTANT: All KHS3040 Wireless Handsets must be fully charged before first use. It takes approximately 3½ hours to charge the handset from fully discharged to its full capacity.

After installing the battery and replacing the cover, place the handset into the charger. The display shows the charging status in line 3. For correct charging the room temperature should be between 32°F and 77°F. The handset must not be placed in direct sunlight. The battery has a built-in heat sensor that will stop charging if the battery temperature is too hot. It is necessary to charge the battery anytime the display shows “BATTERY LOW”, or it cannot be powered on. The LED flashes slowly while charging and lights constantly when the charging is completed. When charging begins the charging status is shown in the third line of the display and the LED flashes slowly. The display goes back to normal mode when fully charged.

Note: When the handset is in the charger, vibrate and B-answer features are not active.

Note: If the battery is fully discharged, up to 10 minutes may pass before the display lights up and charging begins.



Figure 4 Charging Status Display

HANDSET USAGE



Key Functions

The handset has 21 keys.

Two keys are placed at the right side of the handset for volume control. Press the upper or lower key to adjust the volume. Each press adjusts the volume one step up or down.

Key	Key Name	Function
	MENU	Activates the menu structure or exits the menu
	Redial	Menu: Left, Cursor Left After a digit: Delete last digit Long press: Delete all From standby text: Redial menu
	Telephone Book	Menu: Right, Cursor Right After a digit: Store number in telephone book. From standby text: Telephone book read.
	MUTE	Menu: Selection Confirmation or advance to next level. Off hook: Mute Long Press: Power off
	Not Used	Not Used
	R / MAIL	Off hook: Recall On hook: Read Message Long press: Power on
	Off hook/On Hook	Power ON Off Hook / On Hook
*	Asterisk	Long press: Pause for speed dialing
#	Pound	Choose upper or lower case in alphanumeric mode
Digits 0-9	Digits/Alpha	Dialed digits or Alphanumeric values

Powering the Handset Off and On

To power on the handset press and hold the  key for one second. When the handset is turned on, and subscribed to a Base Control Unit (CCFP), the  symbol is shown in the lower left corner of the display.



To power off the handset press and hold the **OK** key for 3 seconds.

Note: when the handset has been outside the coverage area, it may take up to 30 seconds after re-entering the coverage before the handset will power on.



Placing calls

Note: For making or receiving calls the handset must be subscribed to a Base Control Unit (CCFP). The  symbol is shown in the display of the handset to indicate subscription.



Internal Calls

1. Press the  key, to take the handset off hook
2. Enter the extension number to be dialed.
3. Converse
4. Press the  key, to place the handset on hook.



External Calls

1. Press the  key, to take the handset off hook
2. Dial Trunk Group Access Code (i.e. 9)
3. Enter the number to be dialed.
4. Converse
5. Press the  key, to place the handset on hook.



Pre-dial

1. Enter the number to be dialed. (Press and hold the “*” key to enter a pause.)
2. Press the  key, to take the handset off hook
3. Digits are dialed automatically.
4. Converse
5. Press the  key, to place the handset on hook.



Forced Account Code Dialing

1. Press the  key, to take the handset off hook
2. Enter Forced Account Code feature access code (set by telephone system administrator)
3. Enter Forced Account Code
4. Press #
5. Dial Trunk Group Access Code (i.e. 9)
6. Enter the number to be dialed.
7. Converse
8. Press the  key, to place the handset on hook.

Last Number Redial

1. Press the  key, to take the handset off hook
2. Dial #7
3. Digits are dialed automatically.
4. Converse
5. Press the  key, to place the handset on hook.

Speed Dialing

1. Press the  key, to take the handset off hook
2. Dial Speed Dial access code (set by telephone system administrator)
3. Enter 4 digit Speed Dial Code (System: 0000-4999, Station: 9000-9499)
4. Digits are dialed automatically.
5. Converse
6. Press the  key, to place the handset on hook.

Busy Queue



Busy Queue allows a station to queue to a busy internal extension or an outside line. Stations performing a Busy Queue will be notified by ring indication when the internal extension or outside line becomes available.

Set

While receiving busy signal:

1. Press **R**
2. Dial #1
3. Hear confirmation tone
4. Press the  key, to place the handset on hook.
5. Wait for ringing indication

When internal extension or outside line becomes available:

1. Press the  key, to take the handset off hook
2. Wait for called internal extension to answer –OR- hear dial tone and place call.
3. Converse
4. Press the  key, to place the handset on hook.

Cancel

1. Press the  key, to take the handset off hook
2. Dial #1
3. Hear confirmation tone

Answering Calls



When a call is received the display will show “**INCOMING CALL**” and the phone will ring and/or vibrate.

Answer the call by pressing the  key.



It is possible to stop the ring signal without answering the call.

Press **MUTE** and the ring signal will be muted. The display will show “**RINGER MUTED**”



Internal Calls

1. Receiving ringing on handset
2. Press the  key, to take the handset off hook
3. Converse
4. Press the  key, to place the handset on hook

External Calls



1. Receiving ringing on handset
2. Press the  key, to take the handset off hook
3. Converse
4. Press the  key, to place the handset on hook

Selected Trunk/Line Answer

1. Press the  key, to take the handset off hook
2. Dial Access Code (set by telephone system administrator)
3. Enter Trunk/Line number
4. Converse
5. Press the  key, to place the handset on hook

Page Answer

During Page

1. Press the  key, to take the handset off hook
2. Dial #68
3. Converse
4. Press the  key, to place the handset on hook

Calls in Progress

Volume Adjustment

Use the two keys placed at the right side of the handset for volume control

Microphone mute

Press the **MUTE** key. The display will show “**MIC. MUTED**”
Press the **MUTE** key to enable the microphone again.



Holding Calls

Exclusive Hold

With call in progress

1. Press **R**
2. Hear new internal dial tone
3. Dial ##
4. Press the  key, to place the handset on hook

Retrieve Call

1. Press the  key, to take the handset off hook
2. Dial ##
3. Converse
4. Press the  key, to place the handset on hook

Transferring Calls

During a call transfer it is always possible to return to the original call by pressing the **R** key.

Screened Transfer

With call in progress

1. Press **R**
2. Hear new internal dial tone
3. Dial internal extension number
4. Announce call
5. Press the  key, to complete the transfer and place the handset on hook

Unscreened/Blind Transfer

With call in progress

1. Press **R**
2. Hear new internal dial tone
3. Dial internal extension number
4. Press the  key, to complete the transfer and place the handset on hook

Transfer via Paging

With call in progress

1. Press **R**
2. Hear new internal dial tone
3. Dial #6
4. Enter paging zone (00=All Page, or 01-32 for specific group)
5. Announce call over page
6. Wait for page answer
7. Press the  key, to complete the transfer and place the handset on hook

Trunk-To-Trunk (Transfer to Outside Line)

With call in progress

1. Press **R**
2. Hear new internal dial tone
3. Dial Trunk Group Access Code (i.e. 9)
4. Enter the number to be dialed.
5. Announce Call
6. Press the  key, to complete the transfer and place the handset on hook

Conferencing Calls

Depending on system configuration up to 8 parties may be conferenced.

Initiating a new conference call:

With call in progress

1. Press **R**
2. Hear new internal dial tone
3. Dial Trunk Group Access Code (i.e. 9, proceed to step 4) –OR– Dial internal extension number (skip step 4)
4. Enter the number to be dialed.
5. Announce Call
6. Press **R**
7. Dial *2
8. Converse
9. Press the  key, to place the handset on hook

Repeat procedure to add more parties to the conference.

Parking Calls



Call Park

With call in progress

Park

1. Press **R**
2. Hear new internal dial tone
3. Dial *6
4. Hear confirmation tone
5. Press the  key, to place the handset on hook

Retrieve from any handset

1. Press the  key, to take the handset off hook
2. Dial *6 (add extension number if retrieving station is different from parking station)
3. Converse
4. Press the  key, to place the handset on hook



Group Park

With call in progress

Park

1. Press **R**
2. Hear new internal dial tone
3. Enter Group Park Set Access Code (set by telephone system administrator)
4. Dial park orbit number (01-16)
5. Hear confirmation tone
6. Press the  key, to place the handset on hook

Retrieve from any handset within the Pick-Up-Group

1. Press the  key, to take the handset off hook
2. Enter Group Park Answer Access Code (set by telephone system administrator)
3. Dial park orbit number (01-16)
4. Converse
5. Press the  key, to place the handset on hook



Direct Group Park

With call in progress

Park

1. Press **R**
2. Hear new internal dial tone
3. Enter Direct Group Park Set Access Code (set by telephone system administrator)
4. Enter Pick-Up-Group number (01-32)
5. Enter park orbit number (01-16)
6. Hear confirmation tone
7. Press the  key, to place the handset on hook

Retrieve from any handset



1. Press the  key, to take the handset off hook
2. Enter Direct Group Park Answer Access Code (set by telephone system administrator)
3. Enter Pick-Up-Group number (01-32)
4. Enter park orbit number (01-16)
5. Converse
6. Press the  key, to place the handset on hook

Call Forwarding



All handsets will provide stutter internal dial tone while forwarded.

Direct Forwarding

Set

1. Press the  key, to take the handset off hook
2. Dial #91 for Direct Forwarding
3. Dial 0 for day forward or 1 for night forward
4. Enter internal extension to forward to.
5. Hear confirmation tone
6. Press the  key, to place the handset on hook



Cancel

1. Press the  key, to take the handset off hook
2. Dial #90
3. Dial 0 for day forward or 1 for night forward
4. Hear confirmation tone
5. Press the  key, to place the handset on hook



Follow-Me Forwarding

Follow-Me Forwarding allows a user to forward a handset from the destination extension.

Set from destination

1. Press the  key, to take the handset off hook
2. Dial #92 for Follow-Me Forwarding
3. Dial 0 for day forward or 1 for night forward
4. Enter internal extension to forward.
5. Hear confirmation tone
6. Press the  key, to place the handset on hook



Cancel from forwarded station

1. Press the  key, to take the handset off hook
2. Dial #99
3. Dial 0 for day forward or 1 for night forward
4. Hear confirmation tone
5. Press the  key, to place the handset on hook



External Forwarding

External Forwarding allows a user to forward a handset to an outside number.

Set

1. Press the  key, to take the handset off hook
2. Dial #93 for Follow-Me Forwarding
3. Enter outside number
4. Dial #9.
5. Hear confirmation tone
6. Press the  key, to place the handset on hook

Cancel



1. Press the  key, to take the handset off hook
2. Dial #93
3. Dial 0
4. Dial #9
5. Hear confirmation tone
6. Press the  key, to place the handset on hook

Call Pick-Up

Allows a user to answer a call that is in a ringing condition on another handset.



Direct

Upon hearing ringing indication



1. Press the  key, to take the handset off hook
2. Dial *3
3. Dial number of internal ringing extension number
4. Converse
5. Press the  key, to place the handset on hook

Group

Upon hearing ringing indication

1. Press the  key, to take the handset off hook
2. Dial *9
3. Converse
4. Press the  key, to place the handset on hook

Selected Trunk Hold Answer

1. Press the  key, to take the handset off hook
2. Dial Selected Trunk Hold Answer Access Code (set by telephone system administrator)
3. Enter Trunk/Line number
4. Converse
5. Press the  key, to place the handset on hook



Account Code Registry

With call in progress



1. Press **R**, original caller is placed on hold.
2. Hear new internal dial tone
3. Dial #3
4. Enter Account Code
5. Enter #
6. Press **R** to return to original caller
7. Converse
8. Press the  key, to place the handset on hook

Paging

Page

1. Press the  key, to take the handset off hook
2. Dial #6
3. Enter paging zone (00=All Page, or 01-32 for specific group)
4. Perform paging announcement
5. Press the  key, to place the handset on hook



Answer During Page

1. Press the  key, to take the handset off hook
2. Dial #68
3. Converse
4. Press the  key, to place the handset on hook



Do Not Disturb

When Do Not Disturb is active the handset will provide a stutter dial tone.

Set



1. Press the  key, to take the handset off hook
2. Dial *84
3. Hear confirmation tone
4. Press the  key, to place the handset on hook

Cancel



1. Press the  key, to take the handset off hook
2. Dial **84
3. Hear confirmation tone
4. Press the  key, to place the handset on hook

AGENT FEATURES



Log On

5. Press the  key, to take the handset off hook
6. Dial **85
7. Enter 4 digit agent code
8. Hear confirmation tone
9. Press the  key, to place the handset on hook



Log Off

10. Press the  key, to take the handset off hook
11. Dial *85
12. Hear confirmation tone
13. Press the  key, to place the handset on hook



Unavailable

14. Press the  key, to take the handset off hook
15. Dial *868
16. Hear confirmation tone
17. Press the  key, to place the handset on hook

Wrap-Up

18. Press the  key, to take the handset off hook
19. Dial *869
20. Hear confirmation tone
21. Press the  key, to place the handset on hook

Available

22. Press the  key, to take the handset off hook
23. Dial **97
24. Hear confirmation tone
25. Press the  key, to place the handset on hook

HANDSET MENUS

Menu Structure

Pressing the **MENU** key enters or exits the menu tree. It has to be used if a **NO** or a **CLEAR** is wanted in the menu tree. Pressing the **OK** key advances to the next level of a menu. When the lowest menu level is reached, the **✓** key stores the setting and advances to the next highest menu tree level. The **OK** key is used to enter a **YES** when necessary.

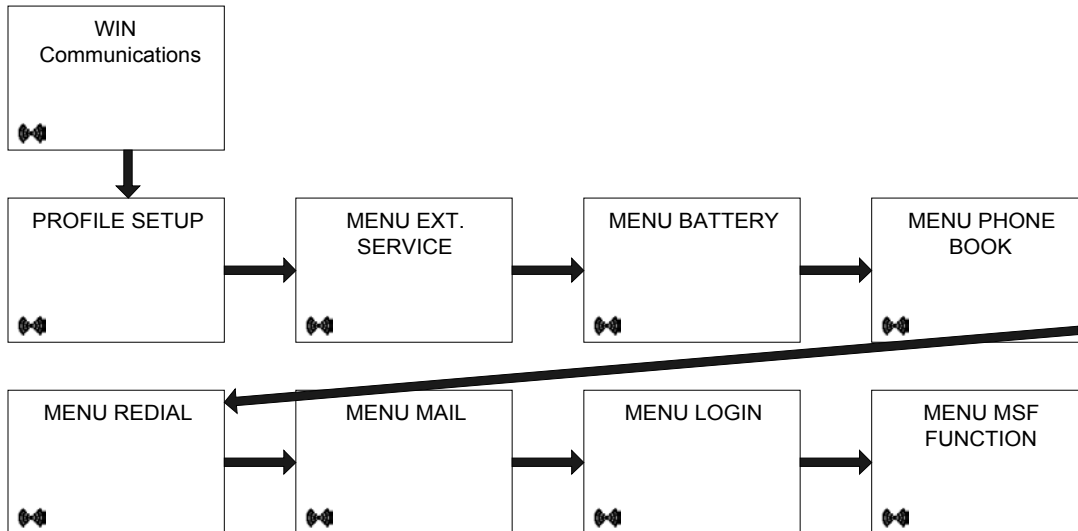

Figure 5 Main Menu

The phonebook and redial menus may be accessed directly. Access the phonebook by pressing the > key. Access the redial menu by pressing the < key.

Profiles

In the Profile menu you will find a description of how to set up one of the 2 profiles. To enter the Profile Setup menu press **MENU**, then press **OK**. Use < and > to find the profile you wish to change and confirm the selection by pressing **OK**. You are now able to switch between the different settings. Press **OK** when you find the setting to be edited or viewed. Change the setting as needed, confirm changes by pressing the **OK** key and automatically advance to the next setting. Press **MENU** to confirm all changes.

A quick way of choosing a profile is to press **MENU** and then 1, 2, or #.

1 = Profile 1

2 = Profile 2

= SILENT

To change the set up in a profile menu press **MENU** followed by **OK** twice. All settings have to be defined under each of the two profiles. The display shows if the **SILENT** mode or **PROFILE2** is chosen.

Profile Features

Note: Confirm all selections by pressing the **OK** key.

- Backlight** Can be toggled off or on using the < and > keys.
- Ringer Tone** Select one of 9 different tones by pressing the < and > keys.
- Ringer Volume** Select the volume level by pressing the < and > keys.
- Key Tones** Select the volume level by pressing the < and > keys.
- Vibrator** Toggle the vibrating mode off or on by pressing the < and > keys.
- B-Answer** Toggle the B-answer mode off or on by pressing the < and > keys
When active, the handset automatically answers incoming calls.

Remark Auto on hook

Start Volume Select the starting volume level by pressing the < and > keys.

Out of Range The Out of Range indication can be toggled using the < and > keys. When activated, a “beep” tone will be audible when the handset is moving out of range of the Base Station (RFP) and “**OUT OF RANGE**” will appear in the display.

Auto Key-lock The Auto Key Lock feature may be toggled using the < and > keys. When activated, the keypad will automatically lock after being idle for 60 seconds. Press **MENU** followed by the “*” key to unlock the keypad.

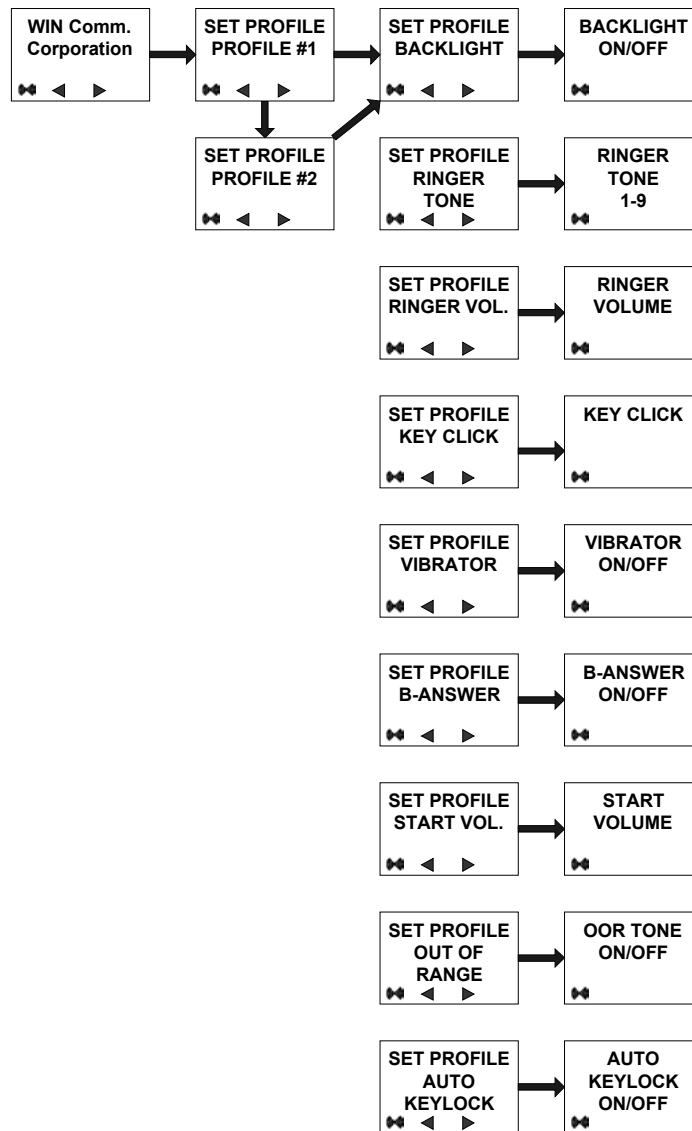

Figure 6 Profile Setup Menu

External Services

External Services are facilities placed in the main system, and are only available when a handset is subscribed to a Base Control Unit (CCFP).

Battery Capacity

In the Battery Menu it is possible to see the remaining battery capacity. For the correct capacity the handset must be placed into the charger for at least one hour.

1. Press **MENU**
2. Use the > and < keys to scroll to the Battery Menu.
3. Press **OK**
4. The current battery capacity is displayed.
5. Press **OK** to return to the menu tree, or press **MENU** to quit.

The indication on the display is not necessarily an exact reflection on the remaining speech time, but only an indication of the remaining voltage of the battery.

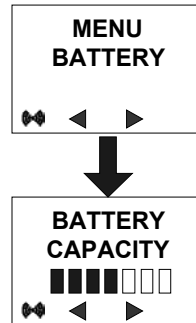



Figure 7 Battery Menu

Telephone book

1. Press the > key to enter the telephone book
2. Search for the number using the < and > keys to search or by pressing the first letter in the name using digits 1-9
3. [Redacted]
4. Converse [Redacted]
5. Press the  key, to place the handset on hook.

The normal dialing keys (0-9) are used for entering the name to be placed in the telephone book. By pressing the keys a certain number of times the related letters or digits will appear in the display. Spaces are entered by using the 0 key. Key # alternates between upper and lower case letters. The < and > keys move the cursor left and right. Press and hold the < key for 1 second to delete a character.

Change of key press and pauses lasting longer than 1 second automatically advances the cursor to the next position.

Alphanumeric Keyboard Functions



Key	
1	Ø β Æ Ä Ö Ü Å @ 1
2	A B C @ Ä Å 2
3	D E F 3
4	G H I 4 Î Ï
5	J K L 5
6	M N O 6 Ó Ô Õ
7	P Q R S β 7
8	T U V Ü Ú Û 8
9	W X Y Z 9
0	Space . , - + : ? ! 0
*	* # / \ () = &
#	Upper / Lower Case

Edit the Phone Book

1. Press the > key.
2. For quick search press the first letter of the desired name by using the keypad.
3. Press the  key to place a call to the displayed number.

Note: Viewing and editing of the Telephone Book can be done while off hook.

Handset Redial Memory

1. Press the < key to enter the redial stack
2. Search for the desired number by using the < and > keys.
3. Press the  key, to take the handset off hook
4. Digits are dialed automatically.
5. Converse
6. Press the  key, to place the handset on hook.

Menu Subscription and Login

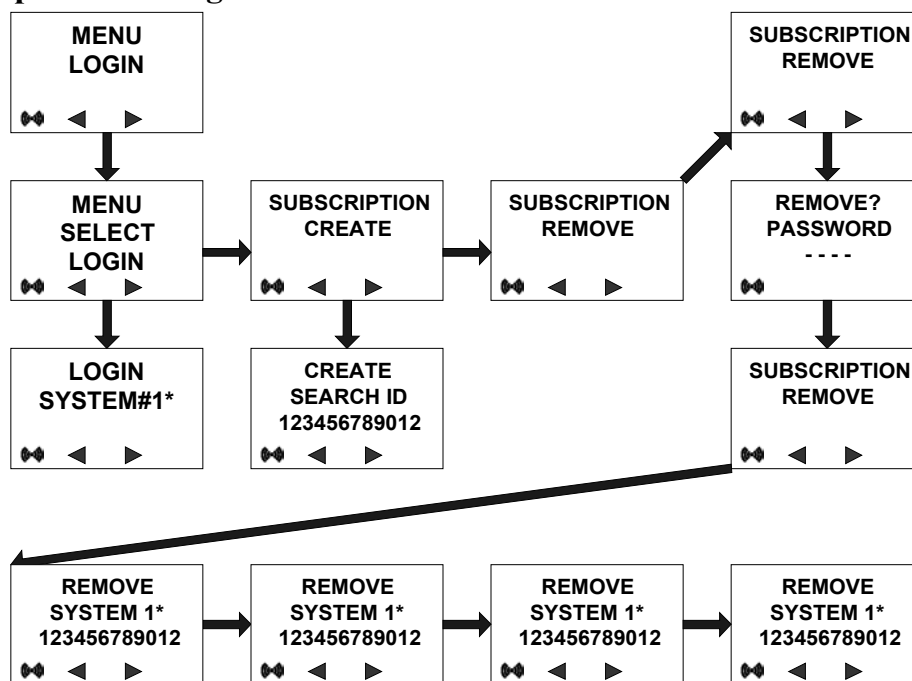



Figure 8 Subscription Menus

Create Subscription

To receive subscriptions from a handset, The Base Control Unit (CCFP), the must be configured to allow subscriptions in the Administration Program. Some Base Control Units (CCFP) also require and Account Code (AC). If more that one Base Control Unit (CCFP) currently accepts subscriptions, the Base Control Unit (CCFP) ID number is required. The system administrator can provide Account Codes (AC) and Base Control Unit (CCFP) ID numbers.

1. Choose the **SUBSCRIPTION CREATE** menu to subscribe your handset to a Base Control Unit.
2. Use the < and > keys to scroll between all active Base Control Unit ID numbers available.
3. During subscription the handset will search for free positions and perform subscription on the first position available.
4. An alternative position can be chosen using the < and > keys.
5. Enter the AC using the keypad and press **OK** to confirm.
6. If the subscription was successful, the startup text will be replaced by the standby text as entered by the system programmer and the  symbol will be displayed.

The handset will support concurrent subscription up to 4 Base Control Units (CCFP).

Login

The handset can be subscribed to 10 different Base Control Units (CCFP). Enabling the user to roam between systems. To change to another Base Control Unit use the login menu to connect to another system number. The actual chosen system is being displayed when the red LED is lit solid. To change to another system, use the < and > keys. Press the **OK** key to confirm the selection.

The Base Control Unit (CCFP) must be configured to accept subscriptions.

Auto Login



The handset can be subscribed to 10 different Base Control Units (CCFP). If Auto Login is enabled, the handset automatically selects a base control unit (CCFP) and performs a login.

Note: Auto Login should only be used in separate systems without coverage overlaps.

Removing Subscriptions

Subscriptions can be removed from the system and from the other 9 systems, if connected. Removing a subscription requires a password. The password is factory defaulted to 0000. If the system in use is removed, it is necessary to login to another remaining system or to create a new system and login. If a new system is not chosen, the handset will remain connected to the system in use.

Text Messages

Text messages may be sent between handsets and may contain a total of 72 characters. Up to 14 messages can be “stored” within each handset. Messages are delivered in a First In First Out sequence. Up to 7 messages can be “locked” within each handset. Once 14 messages have been received to the handset and a new message is received, the oldest, unlocked message will be deleted. When a text message is received the envelope icon  appears in the display. The  icon indicates one or more unread messages. Once all messages are read the  icon will disappear from the display. The first letter in the display indicates the message status

- R Read
- N Unread/New
- L Locked

Reading Text Messages

1. Open the **MAIL** menu by pressing the **R** key followed by the **OK** key.
2. Use the > key to scroll if the message contains more than 36 characters.
3. To view sender information, press the **OK** key.
4. To exit press **MENU**

Reply to a Text Message

1. Open the **MAIL** menu by pressing the **R** key followed by the **OK** key.
2. Press the **OK** key again.
3. Use < and > to select a reply.
4. Press the **OK** key and write a reply using the keypad.
5. Press the **OK** key to confirm and send the Text Message.

Forward a Text Message

1. Open the **MAIL** menu by pressing the **R** key followed by the **OK** key.
2. Press the **OK** key again.
3. Use < and > to select Forward
4. Press the **OK** key twice.
5. Write preface with the keypad
6. Press the **OK** key again to confirm and send.

Delete All Text Messages.

1. Open the **MAIL** menu by pressing the **R** key followed by the **OK** key.
2. Press the **OK** key again.
3. Use < and > to select Delete
4. Press the **OK** key to confirm.

Menu Language

There are 6 predefined languages in the handset.

- English
- Italian
- Spanish
- Dutch
- French
- German

Menu Shortcuts

Note: Shortcuts are performed while the handset is idle unless noted.

Destination Menu	Shortcut
PROFILE 1	Press MENU 1
PROFILE 2	Press MENU 2
SILENT MODE	Press MENU #
KEY LOCKED	Press MENU *
PHONE BOOK	Press the > key
REDIAL	Press the < key
TEXT MESSAGES	Press the R key
MUTE RINGER	Press the OK key while handset is ringing (temporary)
MUTE MICROPHONE	Press the OK key**

** While off hook

Error Codes

Problem	Possible Solution
Handset Freezes	Remove and replace the battery pack. Press to power on the handset.
Handset does not ring	Check is ringer is set to SILENT or if the RINGER VOL. is OFF
Handset cannot find a system ID at “ SUBSCRIPTION CREATE ”	Check if the Base Control Unit is set to allow subscriptions.
The handset cannot subscribe after the Base Control Unit ID has been found.	Check if Access Code (AC) is necessary.
Not able to Power Up the handset	Check if the handset battery is connected. If yes, recharge the battery.
Handset turns off while receiving calls and going off hook.	Charge the battery. If a problem still exists change the battery pack.